



2023
2024
2025

ANCAP TEST PROTOCOL

Whiplash
v4.2



PREFACE

During test preparation, vehicle manufacturers are encouraged to liaise with ANCAP and to observe the way the vehicle is set up for testing. Where a vehicle manufacturer feels that a particular aspect should be altered, they should raise this with the ANCAP assessor present at the test, or in writing to the ANCAP Chief Executive Officer if no assessor is present. ANCAP will consider the matter and at their sole discretion give direction to the test facility.

Vehicle manufacturers warrant not to, whether directly or indirectly, interfere with testing and are forbidden from making changes to any aspect that may influence the test, including but not limited to dummy positioning, vehicle setting, laboratory environment etc.

Illustrations in this protocol are reproduced from Euro NCAP publications, and therefore show Euro NCAP markings on left-hand-drive vehicles. Where relevant, the layouts depicted should be adapted to right-hand-drive application.

VERSION

VERSION	PUBLISHED	DETAILS
3.2	July 2017	First ANCAP version of protocol
4.0	July 2019	
4.1	July 2020	
4.1.1	February 2022	S4.6.2.1 Amended reference to Euro NCAP Technical Bulletin S6.2.4.8 Clarified head restraint test position
4.1.2	August 2022	S7.3.1 word correction S7.4 Table 2 – Amended filter class for sled velocity Appendix III cl 1.7 added filter detail
4.2	April 2024	References to TB021 added and duplicate information removed

DISCLAIMER

ANCAP has taken all reasonable care to ensure that the information published in this protocol is accurate and reflects the current technical decisions taken by the organisation. In the event this protocol contains an error or inaccuracy, ANCAP reserves the right to make corrections and determine the assessment and subsequent result of the affected requirement(s).

COPYRIGHT

Copyright 2024. This work is the intellectual property of ANCAP with certain content reproduced with the permission of Euro NCAP. A license is granted for this material to be shared for non-commercial, educational purposes, provided this copyright statement appears on the reproduced materials and notice is given that the copying is by permission of ANCAP. To disseminate otherwise or to republish will be considered a breach of intellectual property rights.

AUSTRALASIAN NEW CAR ASSESSMENT PROGRAM (ANCAP)

TESTING PROTOCOL - WHIPLASH

Table of Contents	Page No.
1 INTRODUCTION	2
2 DEFINITIONS	3
3 COORDINATE SYSTEM	6
4 SLED SEAT MOUNTING AND POSITIONING	7
5 H-POINT MACHINE & DUMMY POSITIONING	16
6 HEAD RESTRAINT POSITIONS	19
7 BIORID ATD REQUIREMENTS	30
8 TEST SLED REQUIREMENTS	33
9 TEST SLED INSTRUMENTATION	34
10 WHIPLASH ASSESSMENT CRITERIA	35
Appendix I	39
Appendix II	40
Appendix III	46
Appendix IV	49

1 INTRODUCTION

This procedure enables the user to dynamically test a motor vehicle seat and head restraint assembly to assess the extent to which they reflect best practice in preventing soft tissue neck injuries. This test procedure is designed to evaluate all forward facing front seats only: the protection in rear seats is covered by the Rear Whiplash Test Protocol. The details of the seat(s) that will be tested by ANCAP are contained in the ANCAP Vehicle Specification, Sponsorship, Testing and Re-testing Protocol.

The tests are undertaken on a sled and uses the vehicle's seat placed in a similar geometric position as fitted in the test car. A BioRID UN rear crash dummy is used and is seated in a standardised position restrained by a three point belt. This test procedure features two pulses of medium and high severity. The pulse requirements are defined in Appendix III. Only reverse-acceleration sled systems are allowed for the official ANCAP whiplash seat assessment.

As BioRID UN is not a suitable tool for use with more upright seating positions, only torso angles between 20-30 degrees are evaluated. Any vehicles with a design angle outside of this window will be evaluated statically and dynamically with a fixed angle as defined in Section 5.1.26.

2 DEFINITIONS

For the purpose of this procedure, the following definitions shall apply:

- 2.1 Backset means the horizontal distance between the front surface of the head restraint and the rearmost point of the head.
 - 2.1.1 In the context of this protocol, backset is defined as the difference between the Contact Point CP_x (marked on the headrest for the different positions to be assessed) and the X-coordinate obtained from applying the formula in the second column of Appendix IV.
 - 2.1.2 BioRID Reference Backset means the backset as determined in accordance with Section 6.3.1.
 - 2.1.3 BioRID Backset is defined as the horizontal measurement between the back surface of the BioRID head and the selected reference point on the front surface of the head restraint.
 - 2.1.4 Design torso angle means the angle with the H-Point machine between a vertical line through the R-point and the torso line in a position which corresponds to the design position of the seat back specified by the vehicle manufacturer.
- 2.2 Effective top of the head restraint means the highest point on the centreline of the head restraint, determined in accordance with Section 6.2 and is designated as intersection point (IP).
- 2.3 Head restraint means, at any designated seating position, a device that limits rearward displacement of a seated occupant's head relative to the occupant's torso and that has a height equal to or greater than 700 mm at any point between two vertical longitudinal planes passing at 85 mm on either side of the [torso line], in any position of backset and height adjustment, as measured in accordance with Section 6.2.
- 2.4 Head Restraint Measurement Position Definitions
 - 2.4.1 **Down** is defined as the lowest achievable position of an adjustable head restraint regardless of other adjustments (e.g. tilt) and without using tools. The lowest position should be assessed from the point of view of a seated occupant, and without using a third hand.
 - 2.4.2 **Up** is defined as the highest adjusted détente position of an adjustable head restraint (taking into account locking détente positions, as defined in Section 2.9, only).
 - 2.4.3 **Back** is defined as the most rearward adjusted position of an adjustable head restraint, or if this is difficult to ascertain, "back" should be taken as the position which results in the greatest backset when set at the test height.
 - 2.4.4 **Forward** is defined as the most forward locking adjusted position of an adjustable head restraint, or if this is difficult to ascertain, "forward" should be taken as the position which results in the least backset when set at the test height.
- 2.5 **Integrated Head Restraint** or **Fixed Head Restraint** means a head restraint formed by the upper part of the seat back, or a head restraint that is not height adjustable and/or cannot be detached from the seat or the vehicle structure except by the use of tools or following the partial or total removal of the seat furnishings.

- 2.5.1 **Adjustable Head Restraint** means a head restraint that is capable of being positioned to fit the anthropometry of the seated occupant. The device may permit horizontal displacement, referred to as “tilt” adjustment and/or vertical displacement, known as “height” adjustment.
- 2.5.2 **Re-active Head Restraint** means a device designed to improve head restraint geometry during an impact. It will usually be deployed by the occupant’s mass within the seat operating a mechanism during the crash. They also usually re-set after loading to a pre-accident condition.
- 2.5.3 **Pro-active Head Restraint** means a device designed to automatically improve head restraint geometry prior to an impact, which utilises sensors to trigger pyrotechnics, magnetic or other device to release stored energy in order to deploy head restraint or seatback elements. Such systems require no input from the occupant to operate. They are usually not re-settable following a deployment and remain in their deployed state.
- 2.5.4 **Automatically Adjusting Head Restraint** means a head restraint that automatically adjusts its position depending on the stature of the seated occupant.
- 2.6 **Head restraint Height** means the distance from the R50-point, measured parallel to the torso line to the effective top (IP) of the head restraint on a plane normal to the torso line.
- 2.7 **H-point** means the pivot centre of the torso and thigh of the H-point machine when installed in a vehicle seat in accordance with Section 5.1. The H-point is considered fixed in relation to the seat-cushion structure and is considered to move with it when the seat is adjusted in the X direction.
- 2.8 **Intended for occupant use** means, when used in reference to the adjustment of a seat and head restraint, adjustment positions used by seated occupants while the vehicle is in motion, and not those intended solely for the purpose of allowing ease of ingress and egress of occupants; access to cargo storage areas; and or storage of cargo in the vehicle.
- 2.9 **Locking** refers to an adjustable head restraint fitted with a device to prevent inadvertent downward or rearward movement from its adjusted position, i.e. when a rear seat occupant uses a front seat head restraint as a hand hold to facilitate easy entry or exit from the vehicle. A locking device may be fitted to both the horizontal and vertical adjustments of the head restraint. A locking device shall incorporate a mechanism that requires intervention to allow downward/rearward head restraint adjustment after which the mechanism shall re-engage automatically.
- 2.10 **Longitudinal plane** means any plane parallel to the vertical longitudinal zero plane of the vehicle.
- 2.11 **R-point** means a reference point defined for each seat by the manufacturer in relation to the vehicle's structure.
- 2.12 For the purpose of this protocol, **R50-point** means a design point defined by the vehicle manufacturer for the seated 50th percentile male for the designated seating position described in Section 4.6.

- 2.13 H-Point Manikin (HPM)** means the device used for the determination of “H” points and actual torso angles. (SAE Standard J826, SAE Handbook, Vol 3, 1999).
- 2.14 Torso line** means the centreline of the probe of the H-point machine with the probe in the fully rearward position.
- 2.15 Actual torso angle** means the angle measured between a vertical line through the H-point and the torso line using the back angle quadrant on the H-point machine. The actual torso angle corresponds theoretically to the design torso angle.
- 2.16 Rebound** means that the head bounced back after contacting the head restraint.
- 2.17 Seat Movement Definitions.** For an illustration of seat movement definitions, see Euro NCAP Technical Bulletin TB028.

3 COORDINATE SYSTEM

3.1 Sled Coordinates

- 3.1.1 The coordinate system used must be an ordinary Cartesian co-ordinate system with 90° between the axes.
- 3.1.2 The origin for all measurements made using CMM is to be located on the upper surface of a seat mounting bolt hole, in the stationary part of the seat runner. This common origin will provide a means of comparing seat positions across test laboratories, where required. In the first instance, the right hand rear mounting hole shall be used. If this is not present, the next available fixation point shall be chosen, considering available options in the following order: left hand rear, left hand front, right hand front.
- 3.1.3 Alternatively, specific vehicle coordinate systems provided by the manufacturer may be used if compliant with the requirements described in 3.1.1.

3.2 Dummy Coordinates

- 3.2.1 The coordinate system for the BioRID instrumentation used must be in accordance with SAE J211.

4 SLED SEAT MOUNTING AND POSITIONING

For the base seat setup specifications used in Section 4.2 to 4.5, manufacturers will be requested to provide data listed in Appendix I prior to test preparation. Alternatively, physical vehicle measurements may be used. In all cases the vehicle should be placed on level ground with no occupant load and a full tank of fuel. Ensure that the vehicle has its spare wheel and all tools supplied on board and all tyre pressures set to manufacturer's recommendations. For vehicles with active suspension and/or automatic levelling the suspension should be set to a driving speed of 40km/h in normal running conditions as specified by the manufacturer.

All base seat setup specifications must be achieved within 0.2° and 5mm of linear tolerance, with the exception of seat belt attachments.

The head restraint test position should be established on all seats provided for whiplash assessment prior to any installation on the sled. Further details of establishing the correct position are contained in Section 7.2.

4.1 Packaging Issues

4.1.1 ANCAP reserves the right to refuse the sled testing of a seat where the performance of the seat or head restraint could be influenced by the vehicle environment or packaging. There should be no stiff structure in the vicinity of the head restraint that could be contacted by the head in a rear impact or that could influence the dynamic deflection of the seat back. There should be no additional support for the seat back that is not present in the sled test set-up.

4.1.2 Where such circumstances exist, for example with 2 seater sports cars, the vehicle manufacturer may be offered the opportunity to test with a body-in-white or to simulate all relevant structures on the sled set-up. The additional test costs and provision of a body-in-white shall be paid for by the manufacturer in these circumstances.

4.1.3 Where a bulkhead or similar structure prevents the target seat back angle from being achieved, the seat track shall be adjusted forward until the angle is achieved.

4.2 Seat Structure Reference Point

In addition to the coordinate system origin determined in 3.1.2, a further seat structure reference point shall also be chosen. This is defined as a fixed point on the seat structure which stays in the same position relative to the vehicle, independent of any seat adjustment. Record (with a photograph) the location used and ensure that this is consistent between vehicle and sled measurements for a particular seat.

For vehicle manufacturers sourced seat setups, this reference point must also be specified.
Figure 1

Figure 1 shows an example seat reference point being the front left bolt hole, but other non-moving parts of the seat mounting structure are acceptable. The seat structure reference point shall be chosen such that the relationship of the seat to the vehicle floor can be accurately reproduced on the sled.

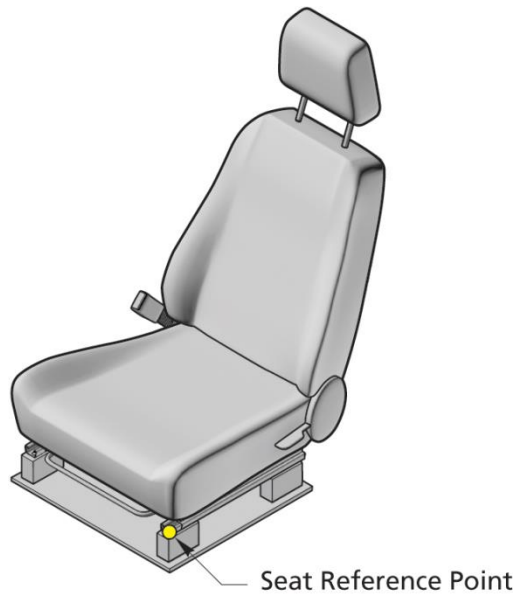

Figure 1: Definition of the Seat reference point.

4.3 Toe Board

The toe board is defined as a simulated floor and toe pan, consisting of a horizontal section sufficiently large to rest the dummy's feet and connected to a section oriented 45° from the horizontal. When positioned for test, the gap between the front of the seat and rear of the toe board shall be no more than 100mm. Both surfaces shall be covered with short-piled carpet. A suitable arrangement is illustrated in Figure 2.

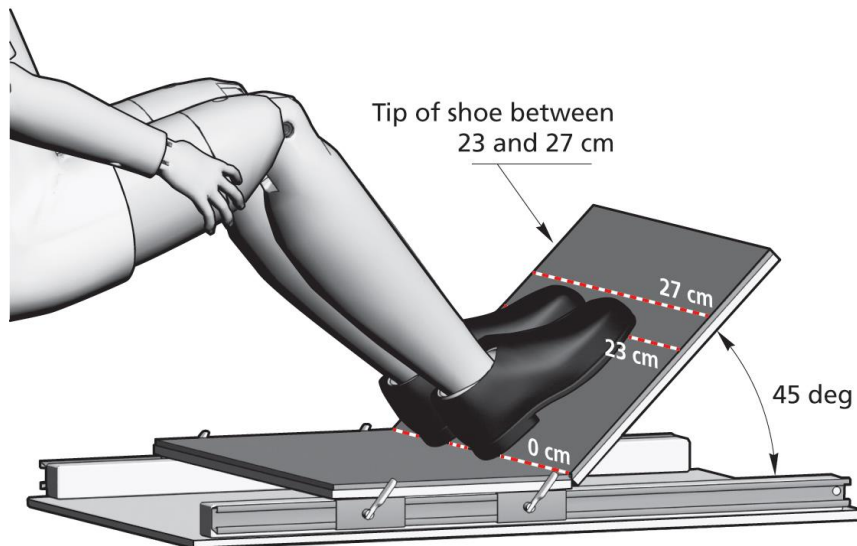

Figure 2: Toe board arrangement showing correct positioning of BioRID feet.

4.4 Heel Surface

The heel surface is defined as the horizontal plane of the toe board (i.e. sled floor or movable footrest) on which the dummy's heel rests. Its target position is determined using the heel rest point location defined from the vehicle measurements, or from information provided by the vehicle manufacturer. An accurate height setting should be obtained at this stage; however an initial approximated horizontal position may be set. The final horizontal position will be obtained in Section 6.4.8.

4.4.1 Heel Rest Point Location

4.4.1.1 Determine the heel rest point location. The heel rest point location is defined in the vehicle (with removable floor mats not fitted) by using the accelerator pedal as follows:

4.4.1.2 Find the geometric centre point of the accelerator pedal contact surface (both laterally and vertically). Place a straight edge between the accelerator pedal centre point and the fixed carpeting on the vehicle floor such that the straight edge is tangential to the accelerator pedal surface at the centre point. The heel rest point location is then the contact point of the straight edge on the vehicle floor, see Figure 3.

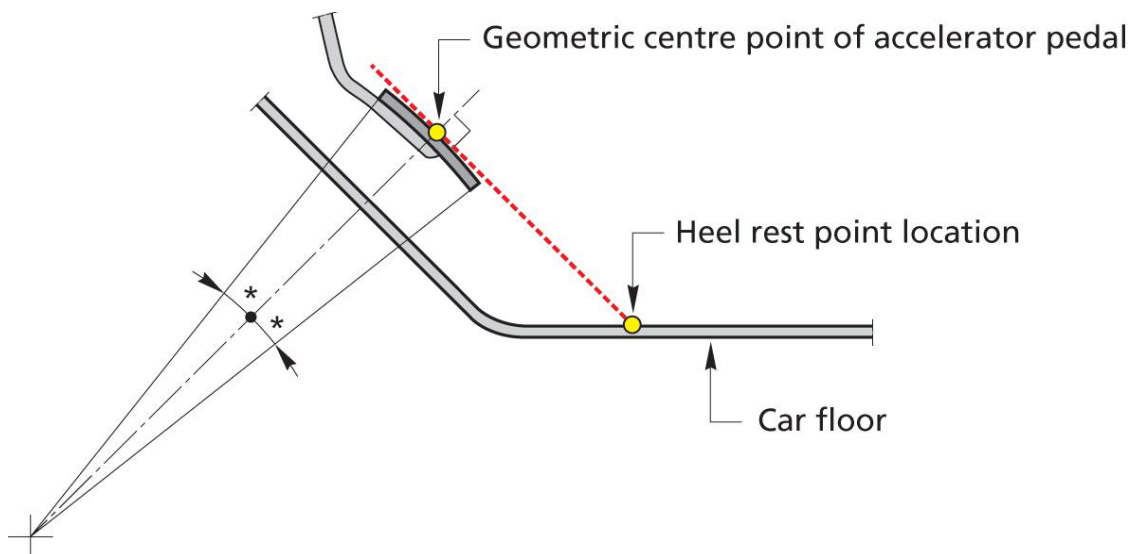

Figure 3: Heel rest point.

4.5 Seat Mounting to Sled

4.5.1 The seat, including all of its adjustment mechanisms and hardware that normally connects it to the vehicle floor (e.g. longitudinal adjustment rails), should be securely fastened to the test sled platform.

4.5.2 The attachment should be made so that the seat's orientation relative to the horizontal is the same as it would be in its vehicle as defined by physical vehicle measurements or vehicle manufacturer data. The actual height of the seat from the sled platform may be different from its height above the vehicle floor.

- 4.5.3 The toe board is also attached to the sled platform. The horizontal floor portion should be mounted at the same height relative to the seat bolts/rails as the heel rest point. The fore/aft position of the toe board should be adjustable. Figure 4 shows an example seat both in-vehicle and mounted on the sled platform.
- 4.5.4 The seat structure reference, seat rail angle and heel rest point should be recorded in the test report. Seat mounts should be rigid and non-deformable, and the seat mount interface to the seat should approximate that of the interface to the vehicle floor. The vehicle manufacturer will be asked to provide details of the relevant seat mounting measurements/tolerances and will be invited to examine the fixture prior to test. Alternatively, the car manufacturer may provide the test lab with a suitable seat attachment frame or fixture.

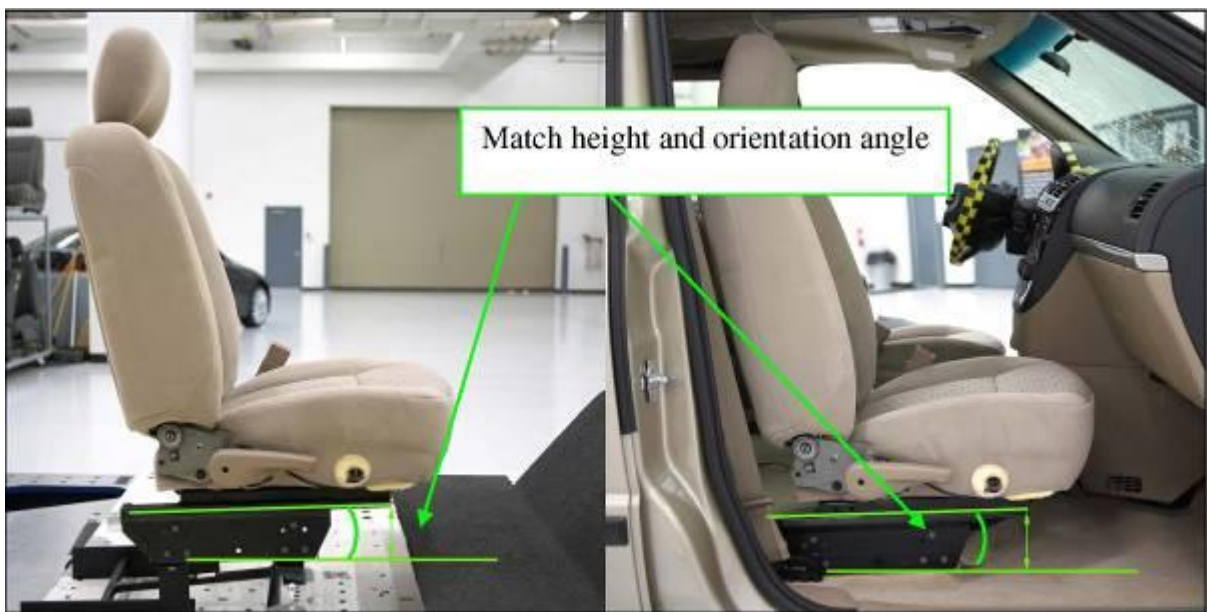

Figure 4: Attachment of seat to test sled.

4.6 Seat Position

- 4.6.1 Seats with Automatically Adjusting Head Restraints. The BioRID UN dummy used for these dynamic tests represents a midsize adult male driver or vehicle occupant. Consequently, seats equipped with head restraints that automatically adjust depending on other seat adjustments (e.g. seat track or height) should be set to a position most likely to be used by a seat occupant of the same size as the dummy. Therefore, the seat shall be adjusted to its mid track and mid height position.

Since the seat's starting position can affect the final position of the head restraint, a consistent setup sequence should be followed. During setting of the mid/mid position, the seat should always be moved rearward from the forward most position, and downward from the fully up position. The seatback should then be positioned following the procedure in Section 5.1. All other seat settings that have not already been adjusted shall be set according to Section 4.6.2.

4.6.2 Setting Manual Seat Adjustments. The various seat adjustments possible on many modern vehicle seats should be set according to the following instructions. Because the setting of some adjustments may affect the adjustment range of other adjustments, the seat should be set by following the order of the procedure outlined here. The seat shall have been at room temperature for at least six hours and not loaded for at least one hour previous to the initial installation of the H-point manikin. Following this pre-conditioning, the seat set up may be undertaken. The seatback angle will be set in Section 5.1, the initial setting is not important so long as it doesn't interfere with other adjustments.

Seat adjustments should now be set using the sequence described in Section 4.6.2.1 to 4.6.2.9. Subsequent seat adjustments may affect the original position of a previous setting. If this is the case there should be no re-adjustment of the previous settings.

4.6.2.1 Initial Adjustment of Seat Adjustment Controls. All seat controls should be set in sequence as follows. Euro NCAP Technical Bulletin TB 028 provides more detailed descriptions with illustration of each of these seat adjustments.

- Seat track should be in its most rearward locking position.
- Seat height should be set to its lowest position.
- Seat tilt should be set to the extreme of its range that puts the cushion angle closest to zero (horizontal). Section 4.6.2.2 describes the method for measuring the cushion angle.
- Cushion height should be set to its lowest position.
- Cushion tilt should be set to the extreme of its range that puts the cushion angle closest to zero (horizontal). Section 4.6.2.2 describes the method for measuring the cushion angle.
- Lumbar support should be set to its most rearward or least prominent position.
- Upper seat back, if separately adjustable from the lower portion should be rotated fully rearward.
- Cushion extension should be set to its most rearward or least extended position.
- Side bolsters should be set to the widest position.
- Arm Rests should be set in the stowed position.

4.6.2.2 Measurement of Cushion Angle. Locate and mark a point on the forward edge of the top surface of the seat cushion and midway between the right and left edges of the cushion. Locate, mark, and record a second point that is 400mm rearward along a line parallel to the direction of the sled movement. The cushion angle is the reading from a digital protractor sitting on the surface of the seat with the rearmost end on the rear seat mark. A suitable length protractor should be chosen such as the entire length of its underside (measurement surface) is in contact with the central panel of the seat cushion. The angle measurement should not be influenced by padding or bolstering on the front of the seat base.

Alternatively, if a coordinate measurement machine (CMM) is used to record the locations of the seat marks, then the *Sine* of the cushion angle is the difference in the Z-coordinates (in mm) of these 2 points (first minus second) divided by 400mm. See Figure 5.

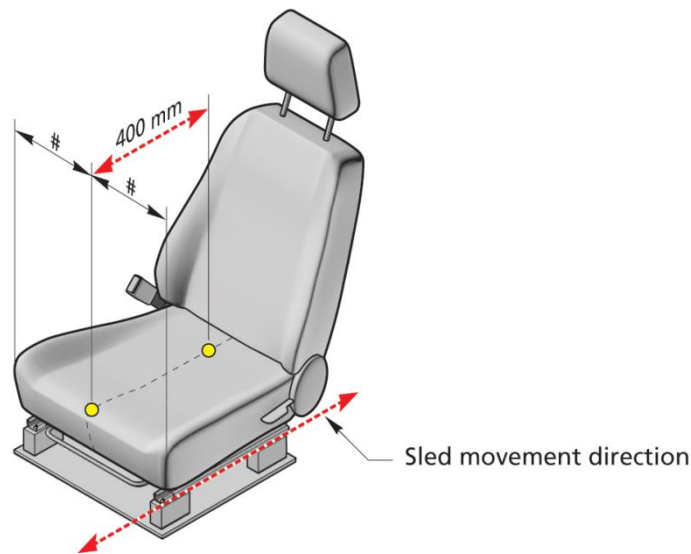

Figure 5: Measurement of cushion angle.

4.6.2.3 Setting Seat Track Adjustment to Midrange. Mark both sides of the seat track and adjacent portion of the seat support structure. Move the seat to its most forward most locking adjustment position and mark the seat track adjacent to the repositioned marks on either side of the seat support structure. On both sides of the seat, measure the distance between the two seat track marks and mark the track midway between the first two marks.

Alternatively, a CMM may be used. With the seat in the rearmost position, mark a hard point on the seat and record its location. Move the seat to its most forward adjustment position and record the position of the seat hard point.

Move the seat rearward until the mark on the seat support structure aligns with centre seat track mark, or until the marked hard point is midway between the two previously recorded hard point locations. The final position will depend on whether the seat track adjusts continuously or incrementally.

The seat should be checked to ensure that both seat runners are set and locked correctly. In some cases there may be different amounts of travel between the two seat runners, care should be taken to ensure that in such cases both seat runners are locked in the correct positions.

4.6.2.3.1 Continuously Adjusting Seat Track. The seat mark should align ($\pm 2\text{mm}$) with the mid-track mark. Alternatively, the hard point should have an X-coordinate that is midway ($\pm 2\text{mm}$) between the X-coordinates of the forward most and rearward most adjustment positions.

4.6.2.3.2 Incrementally Adjusting Seat Track. If the midrange adjustment does not correspond to an incremental adjustment position ($\pm 2\text{mm}$), then the seat should be set to the first incremental position rearward of the calculated midrange position.

4.6.2.4 Setting Seat Height Adjustment to Midrange. Mark two hard points on the side of the seat, which are attached to and move with the cushion frame, one near the front of the cushion and one near the rear. Record the locations of both points with a CMM or measure the vertical heights of the points relative to a fixed reference with a measuring tape. Use the seat height adjuster control(s) to move the seat to its highest position. If the front and rear of the seat adjust separately, then make sure that both the front and rear of the seat are raised to their highest positions.

Record the locations of the two hard points with the CMM or measure the vertical heights of the points relative to a fixed reference with a measuring tape. Then lower the seat until both hard points are midway between their highest and lowest positions. The final position will depend on type of seat height adjuster.

4.6.2.4.1 Single Control Seat Height. If the height is controlled by a single adjuster, its final position will depend on whether it is continuously or incrementally adjusting.

4.6.2.4.1.1 Continuously Adjusting Seat Height. For single control height adjusters, the rear hard point should be $\pm 2\text{mm}$ of the calculated midpoint.

4.6.2.4.1.2 Incrementally Adjusting Seat Height. If the midrange adjustment does not correspond to an indexed adjustment position ($\pm 2\text{mm}$), then the seat should be set to the first indexed position below the calculated midrange position.

4.6.2.4.2 Dual Control Seat Height. If the front and rear of the seat adjust separately, then use the front adjuster to lower the front hard point and the rear adjuster to lower the rear hard point. The final position will depend on whether it is continuously or incrementally adjusting. Note that the adjustment of the front and rear controls may need to be iterated in order to achieve the calculated midpoints.

4.6.2.4.2.1 Continuously Adjusting Seat Height. Both hard points should be $\pm 2\text{mm}$ of the calculated midpoints. If this is not possible, then the rear hard point should be $\pm 2\text{mm}$ of the calculated midpoint and the front hard point as close to the calculated midpoint as possible.

4.6.2.4.2.2 Indexed Adjusting Seat Height. If either midrange adjustment does not correspond to an indexed adjustment position ($\pm 2\text{mm}$), then it should be set to the first indexed position below the calculated midrange position for the corresponding seat hard point.

4.6.2.5 Setting Cushion Height Adjustment. The cushion height adjustment uses the points marked on the top surface of the cushion in Section 4.6.2.2.

4.6.2.5.1 Single Control Cushion Height Adjustment. Raise the cushion to its highest adjustment and record the position of the rear cushion point (400mm behind front edge point). Lower the seat cushion to its mid-position. The final position will depend on whether it is continuously or incrementally adjusting.

4.6.2.5.1.1 Continuously Adjusting Seats. The rear cushion point should have a Z-coordinate midway ($\pm 2\text{mm}$) between the lowest (initial) and highest positions.

4.6.2.5.1.2 Incrementally Adjusting Seats. If the midrange adjustment does not correspond to an indexed adjustment position ($\pm 2\text{mm}$), then the seat cushion height should be set to the first indexed position below midrange.

4.6.2.5.2 Dual Control Cushion Height Adjustment. Use the rear cushion height adjuster to raise the rear of the cushion to its highest position and record the location of the rear cushion point (400 mm behind front edge point). Again using the rear cushion

height adjuster, lower the rear of the cushion so that the rear cushion point is midway between the lowest (initial) and highest positions. Use the front cushion height adjuster to raise the front of the cushion until the cushion angle matches the angle recorded in step 4.6.2.2. The final position will depend on whether it is continuously or incrementally adjusting. Note that the adjustment of the front and rear controls may need to be iterated in order to achieve the calculated midpoints.

- 4.6.2.5.2.1 Continuously Adjusting Seat Height. The rear seat point Z-coordinate should be $\pm 2\text{mm}$ of the calculated midpoint and the cushion angle should match that recorded in step 4.6.2.2 to within ($\pm 0.5^\circ$).
- 4.6.2.5.2.2 Indexed Adjusting Seat Height. If the midrange adjustment of the rear adjuster does not correspond to an indexed adjustment position, then it should be set to the first indexed position below the calculated midrange. Likewise, if the cushion angle from 4.6.2.2 cannot be matched ($\pm 0.5^\circ$) with the front adjuster adjusted to an indexed position, then set the front adjuster to the next lowest indexed position.
- 4.6.2.6 Adjust the lower and upper (where present) seatback angle to conform to the design position provided by the manufacturer. This may be done with the use of identifiable 'hard points' provided by the OEM on the seat frame, head restraint tubes, recliner or similar defined structures.
- 4.6.2.7 If no seatback design position has been provided, adjust only the upper seatback angle to mid as detailed in 4.6.2.8.
- 4.6.2.8 Adjusting Upper Seatback Angle. Measure the angle relative to vertical of the head restraint support post or some flat part of the seatback frame. Without changing the adjustment of the lower seatback, move the upper seatback to its most forward position and measure the angle of the head restraint post or seatback frame. Adjust the upper seatback rearward until the head restraint post or seatback frame angle is midway ($\pm 0.5^\circ$) between the rearmost and forward most angles.
- 4.6.2.9 Other Seat Adjustments. Seat adjustments not set in steps 4.6.2.2 to 4.6.2.6 shall remain in the initial adjustment as set in section 4.6.2.1.
- 4.6.2.10 If the seat is new and has never been sat on, a person of mass $75\text{kg} \pm 10\text{kg}$ should sit on the seat for 1 minute, twice, to flex the cushions.

4.7 Seat Belt

- 4.7.1 A generic three point lap-shoulder seat belt equipped with an inertia reel should be used during the test, placed in such a way that the belt, when worn by the ATD, should lie across the torso, clavicle and pelvis, and must always be routed above the pelvic angle gauge.
- 4.7.2 For generic seat belts, where a seat is equipped with anchorages or buckles, these may be used. Any anchorages not attached to the seat should be positioned as shown in Figure 6. The marks, which correspond to the arrangement of the anchorages, show where the ends of the belt are to be connected to the sled. The anchorages are the points A, B and K. The tolerance on the position of the anchorage points is such that each anchorage point should be situated at most at 50mm from corresponding points A, B and K indicated in Figure 6.
- 4.7.3 If a fourth anchorage is necessary to attach the retractor, this anchorage:
 - should be located in the vertical longitudinal plane passing through K,
 - should be located 770mm vertically below K.

In the case of a belt equipped with a belt adjustment device for height, this device should be secured to a rigid frame.

- 4.7.4 The structure carrying the anchorages must be rigid and should be so constructed that no permanent deformation shall occur in the parts bearing the anchorages during the test.

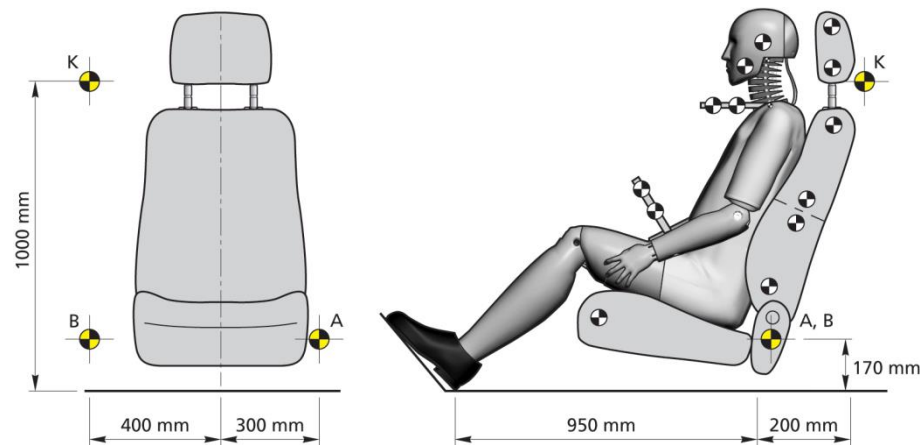

Figure 6: Generic seat belt anchorage mounting.

- 4.7.5 Where a manufacturer requests and can demonstrate good reason for doing so to the Secretariat, vehicle specific belts and geometry may be considered. In this case or when testing seats equipped with integrated belts the vehicles own seat belt hardware (retractor and buckle) should be used. Seat belt geometry and restraint equipment should then be used that approximates that of the test vehicle. Where this is agreed, the vehicle manufacturer will be asked to provide details of the relevant mounting measurements/tolerances and will be invited to examine the fixture prior to test. Alternatively, the car manufacturer may provide the test lab with an attachment frame or fixture.

- 4.8 Triggering of Active Elements.** For each seat it should be ascertained from manufacturer data whether active elements (e.g. pro-active head restraint or seat belt pretensioner) are fitted, and whether they would be triggered for each of the test pulses. For each element which requires a trigger, Time to Fire (TTF) should be specified by the vehicle manufacturer for each pulse if required. Supporting data should be provided by the manufacturer to show that the system always triggers throughout the entire range of rear impact scenarios considered by ANCAP. For example, the low severity RCAR bumper test would be considered.

5 H-POINT MACHINE & DUMMY POSITIONING

5.1 H-point Manikin Installation

- 5.1.1 The seat shall be covered with a cotton cloth large enough to cover both cushions and seatback.
- 5.1.2 The cloth shall be tucked into the seat joint by an amount sufficient to prevent hammocking of the material.
- 5.1.3 The H-point manikin shall be installed in the seat.
- 5.1.4 The lower legs shall be adjusted to the 50th percentile leg length setting, and the upper legs shall be adjusted to the 10th percentile leg length setting; these are the HPM settings closest to the ANCAP front and side impact protocol settings.
- 5.1.5 The legs shall be attached to the HPM and set to the 5th position (no.5) on the knee joint T-bar, which places the knees 250mm apart.
- 5.1.6 With the legs attached and the back pan tilted forward, the HPM shall be positioned in the seat such that its mid-sagittal plane coincides with the longitudinal centreline of the seat. The centreline of the seat may be defined from features such as the head restraint support tubes or seatback and seat pan side bolsters. Particular attention should be paid to seats with asymmetric design.
- 5.1.7 The back pan shall be straightened to conform to the vehicle seat back.
- 5.1.8 The feet shall be placed as far forward as possible, with the heels resting on the heel plane and the feet positioned at 90° to the tibias. The toe pan shall be positioned sufficiently far away so as to avoid any interaction with the feet during the HPM installation process.
- 5.1.9 The lower leg and thigh weights shall be attached to the HPM and the assembly shall be levelled.
- 5.1.10 The back pan shall be tilted forward to 45° from the seat back and the HPM assembly pushed rearward until the seat pan contacts the vehicle seat back. While maintaining the back pan at 45° to the seat back, a horizontal rearward force of 100N shall be applied using the plunger if present or using a force gauge pressed against the hip angle quadrant structure.
- 5.1.11 The load application shall be repeated and, while keeping the 100N applied, the back pan shall be returned to the vehicle seat back and the load then released. As the 100N is released, a small force should be maintained on the front of the T-bar to prevent any longitudinal movement. This support should be maintained until the end of Section 5.1.16 is reached.
- 5.1.12 A check shall be made to determine that the HPM is level, facing directly forward, and located in the centreline of the seat.
- 5.1.13 After estimating the vehicle seat back position, the right and left buttock weights shall be installed. The eight chest weights shall be installed by alternating left to right. Throughout the weight installation, maintain a light pressure to the T-bar preventing any longitudinal movement.
- 5.1.14 Where no OEM information has been provided regarding seat back angle, the HPM torso angle shall be measured by placing an inclinometer on the calibrated back angle surface of the H-point machine.

- 5.1.15 Tilting the back pan forward to a vertical position, the assembly shall be rocked from side to side over a 10° arc, 5° in each direction. Where seat side bolsters prevent movement of up to 5°, the assembly should be rocked as far as permissible. This rocking shall be repeated twice, making a total of three complete cycles. Care should be taken to maintain support of the T-bar during the rocking action, and to ensure that no inadvertent exterior loads are applied. Ensure that the movements of the HPM feet not restricted during this step. If the feet change position, they should be allowed to remain in that attitude for the time being.
- 5.1.16 Holding the T-bar to prevent the HPM from sliding forward on the seat cushion, the back pan shall be returned to the vehicle seat back, and the HPM shall be levelled.
- 5.1.17 To ensure a stable torso position, apply and release a horizontal rearward load, not to exceed 10N, to the back pan moulding at a height approximately at the centre of the torso weights. Care shall be exercised to ensure that no exterior downward or lateral loads are applied to the HPM.
- 5.1.18 Each foot shall be alternately lifted off the floor via the instep until no additional forward foot movement is available.
- 5.1.19 The 45 degree plane of the toe board should be moved toward the feet such that the tip of the toe lies between the 230mm and 270mm lines taking care not to disturb the position of the HPM. To facilitate easier setting of BioRID, the toe board should be moved such that the toes of the HPM feet are positioned nearer to the 230mm line.
- 5.1.20 When each foot is in its final position, the heel shall be in contact with the floor, and the sole of the foot shall be in contact with the 45 degree plane of the toe pan between the 230mm and 270mm lines.
- 5.1.21 If the HPM is not level after the feet have been repositioned, a sufficient load shall be applied to the top of the seat pan to level it on the vehicle seat. This may be verified using the bubble gauge fitted to the manikin or alternatively by verifying with CMM that the H-point positions on both sides of the machine are within $\pm 2.5\text{mm}$ of each other.
- 5.1.22 Set the seat back angle to the manufacturers design position ($\pm 1^\circ$) for a 50th percentile male. If no design position is provided, set the seat to a torso angle of $25^\circ \pm 1^\circ$. Check that the actual torso angle is coincident ($\pm 1^\circ$) to the manufacturer's torso design specification.
- 5.1.23 If the actual torso angle is outside of this tolerance, remove the manikin and make the minimal adjustments to the lower seatback angle.
- 5.1.24 Reinstall the manikin from Section 5.1.3 onwards and check that it is coincident with the manufacturer's torso design specification ($\pm 1^\circ$). For example, if the torso design angle is 23.0° and the measured torso angle is 24.1° , adjust the angle until a measurement of 24.0° is achieved. This may be done with the use of identifiable hard points on the seat frame.
- 5.1.25 Where no design position is provided, set the lower seatback angle to read an actual torso angle of $25^\circ \pm 1^\circ$. Record the final torso angle value.
- 5.1.26 For torso design angles below 20° , testing shall be carried out at 20° . For torso design angles above 30° , testing shall be carried out at 30° .
- 5.1.27 For seats with indexed recliner adjustments, use the closest locking position to the target torso design angle between 20° - 30° . This may require measurements in two different inclinations.

5.2 Record the location of the HPM H-Point Markers

- 5.2.1 Record the H-point positions on both sides of the HPM using a CMM or other means to record the location of both H-points relative to the seat or sled.
- 5.2.2 The H-point position on both sides of the machine shall be within $\pm 2.5\text{mm}$ of each other in X and Z. If this is not the case, the installation procedure from 5.1.6 shall be repeated.
- 5.2.3 Check that the measured H-point corresponds to the R50-point specified by the Vehicle manufacturer ($\pm 10\text{mm}$). Where no R50-point specification has been provided, record the position.

5.3 Repeat measurements

- 5.3.1 Section 5.3 is only applicable if no design position for the seat back or R50-point has been provided by the manufacturer, or if the checks described in sections 5.1.22 or 5.2.3 result in values outside of the specified tolerances.
- 5.3.2 Remove the H-Point Machine and repeat Sections 5.1 to 5.2.3 two further times and record ALL measurements taken for each installation. For the repeat installations, the seat back angle should not be adjusted. However, where a change in seat back angle is required to obtain the required torso angle, the installation procedure shall be repeated until three consecutive installations have been performed which require no seat back angle adjustment.
- 5.3.3 For each individual seat, ensure that the H-point X and H-point Z are within a box of 5mm between the three sets of measurements. Outlying measurements should be investigated and repeated to achieve consistent static measurement results as necessary.
- 5.3.4 Once each individual seat has been measured three times, calculate the average H-Point position and average actual torso angle. These should be within the tolerances specified in sections 5.1.22 for the actual torso angle and 5.2.3 for the H-Point. If the H-point is still not within tolerance, then the average measured H-point position shall be used.

6 HEAD RESTRAINT POSITIONS

6.1 Head Restraint Test Positions

The same head restraint position should be used for both tests. If any variability exists in the locking mechanism, such as different levels of friction that affect that head restraint position then the ANCAP Secretariat should be informed immediately. The decision of the position to be used in the tests shall be made by the Secretariat. Where there is damage to a seat which affects the test position, details should be noted by the test laboratory and provided in the test report, that seat should not be used for test.

6.1.1 Head Restraint Test Position. The test position for the head restraint depends on whether it is fixed or adjustable and, if adjustable, whether the adjustments lock. Automatically adjusting head restraints are tested as if they are fixed restraints and the seat adjustments are set according to Section 4.6.1.

6.1.2 Non-Locking Adjustable Head Restraint. The head restraint is first adjusted to its lowest vertical adjustment position as defined in Section 2.4.1. If a non-locking tilt adjustment is available, this should then be set to the most rearward horizontal adjustment position possible once the head restraint has been set to its lowest position.

6.1.3 Locking Adjustable Head Restraints, Midrange Positions. The head restraint is adjusted to midrange of its vertical and/or horizontal adjustment positions. Only locking adjustments are set to the midrange positions. For example, a restraint with locking height adjustment and non-locking horizontal adjustment would be set to its midrange vertical position and most rearward horizontal position. The head restraint should first be set for the midrange vertical position. Midrange tilt position should then be set where this adjustment has locking notches.

6.1.3.1 Setting of Mid Range Height

6.1.3.1.1 Lowest Position. Some head restraints can be lowered below the lowest locking position and in these cases the bottom of the restraint may contact the top of the seatback. The lowest vertical adjustment position is defined in Section 2.4.1.

6.1.3.1.2 Highest Position. The highest position is considered to be the highest locking position. If a restraint has a non-locking position above the highest locking position, then the highest locking position is still considered as the highest position, see Figure 7.

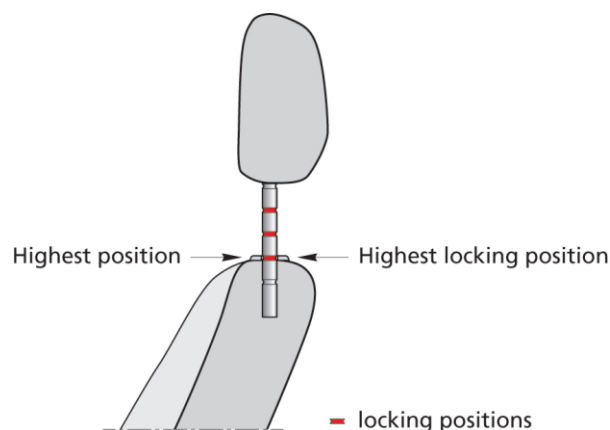

Figure 7: Examples of adjustment positions for head restraints with non-locking positions above/and or below the locking positions

- 6.1.3.1.3 When measuring the head restraint travel for the midrange positions, the seat must be adjusted according to Section 4.6, the seatback must be adjusted according to Section 5 and the HPM should be installed in the seat according to Section 5.
- 6.1.3.1.4 Mark a repeatable reference point on the top of the head restraint. This point is typically the highest point on the centreline of the head restraint. Using a coordinate measurement device, this point should first be measured in the lowest position as defined by in Section 2.4.1, and then in the highest locking position without altering tilt or any other seat settings.
- 6.1.3.1.5 Midrange height position is determined by calculating the geometric mid point between the lowest position, and highest locking vertical adjustments, considering only the vertical component of measurement, see Figure 8. The test position will then be selected based on the following conditions:
- 6.1.3.1.5.1 Place the head restraint at the geometric mid point if a locking position exists there, see Figure 8, Example A.
- 6.1.3.1.5.2 If there is no locking position at the geometric mid point, raise the head restraint by up to 10mm. If a locking position exists within this 10mm of travel, that position will be the test position, see Figure 8, Example B.
- 6.1.3.1.5.3 If there is no locking position within 10mm above the geometric mid point, lower the head restraint to the next lowest locking position, see Figure 8, Example C.
- 6.1.3.1.5.4 If there is no locking position before the lowest or stowed position is reached, then the head restraint should be positioned fully down.
- 6.1.3.1.5.5 Once the vertical test position has been determined, ensure the head restraint is returned to rearmost tilt position.

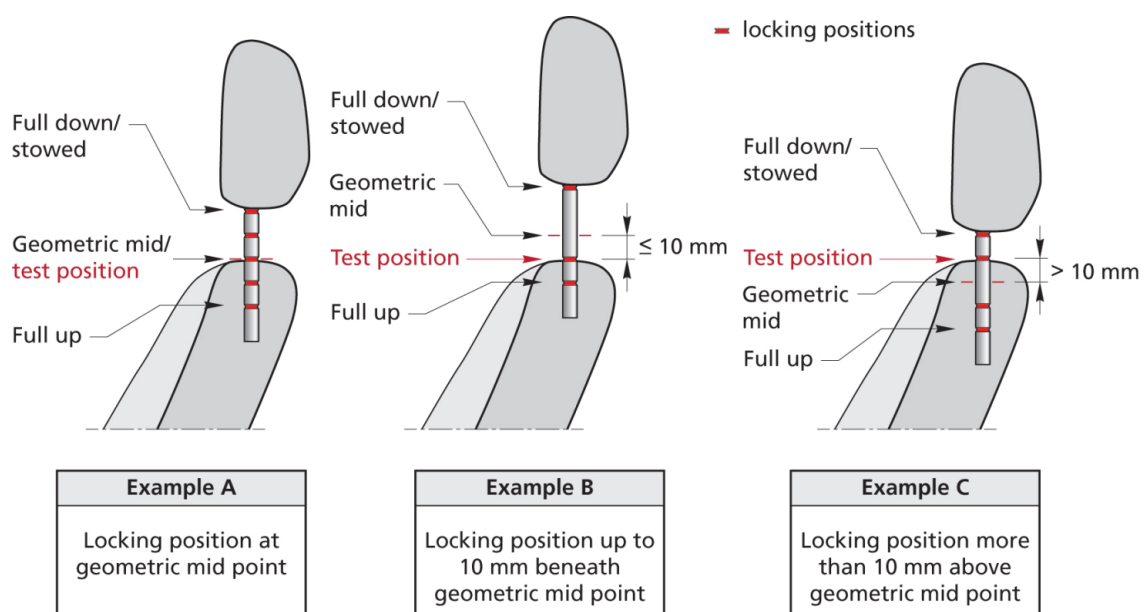

Figure 8: Examples of test position for head restraints with various locking configurations.

6.1.3.2 **Setting of Mid Range Tilt (Locking Tilt Settings Only)**

- 6.1.3.2.1 Following the setting of midrange height, the procedure should be repeated for locking horizontal adjustments. For non-locking tilt adjustments, the head restraint should be tilted fully rearward.
- 6.1.3.2.2 Most Rearward Tilt shall be that which results in greatest backset measurement. In the situation where the head restraint cannot be placed at most rearward tilt. For example due to a return spring, the most “most rearward tilt” shall be the most rearward position in which the tilt can be locked.
- 6.1.3.2.3 Most Forward Tilt shall be determined by finding the most forward locking tilt position. Non-locking positions located further forward than the most forward lock are disregarded. If no locking position exists, the head restraint should be tilted rearwards until a locking position is reached. This position shall then be considered “most forward tilt”.
- 6.1.3.2.4 Midrange Tilt Position is determined by calculating the geometric mid point between the most rearward tilt and most forward locking horizontal adjustments. A locking position shall be sought within a window 10mm forwards from the geometric mid point. If a lock is found within this window, that position shall be considered the test position. In the absence of a lock within this range the head restraint should be moved rearwards until the next locking position is reached. If no locking positions are reached before the fully rearward tilt position, then fully rearward tilt shall be the test position.

6.2 **Measure and Record the Head Restraint Geometry**

6.2.1 Before measuring the head restraint geometry ensure that:

- The seat is set according to Section 4.6.
- The H-point machine is correctly installed in the seat according to Section 5.
- The head restraint is set in the correct test position according to Section 6.1.

6.2.2 When measuring backset and height, a light force (e.g. 1N) should be applied, if needed, to ensure that any trim covering material is in contact with the underlying foams, or that the separation of trim material has not provided artificially favourable measurements.

6.2.3 All measurements shall be taken in the median longitudinal plane of the designated seating position.

6.2.4 Determination of contact point (CP)

6.2.4.1 Adjust the head restraint to the position determined in Section 6.1.

6.2.4.2 The CP is defined as the intersection of a horizontal line, on the height of the Z-coordinate of the back-of-head of the mid-sized male (detailed in Appendix IV), with the front surface of the head restraint as indicated in Figure 9.

6.2.4.3 Once established, the point CP is a seat reference point (x and z coordinates), see Figure 11.

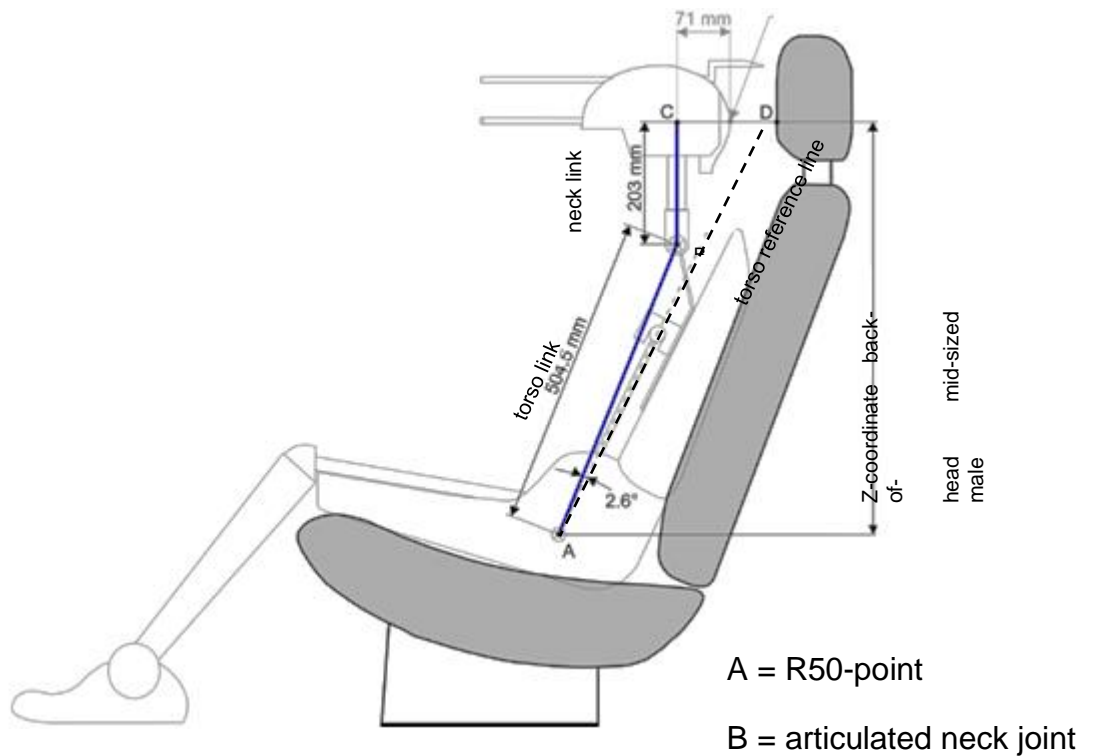

Figure 9: Head restraint measurement

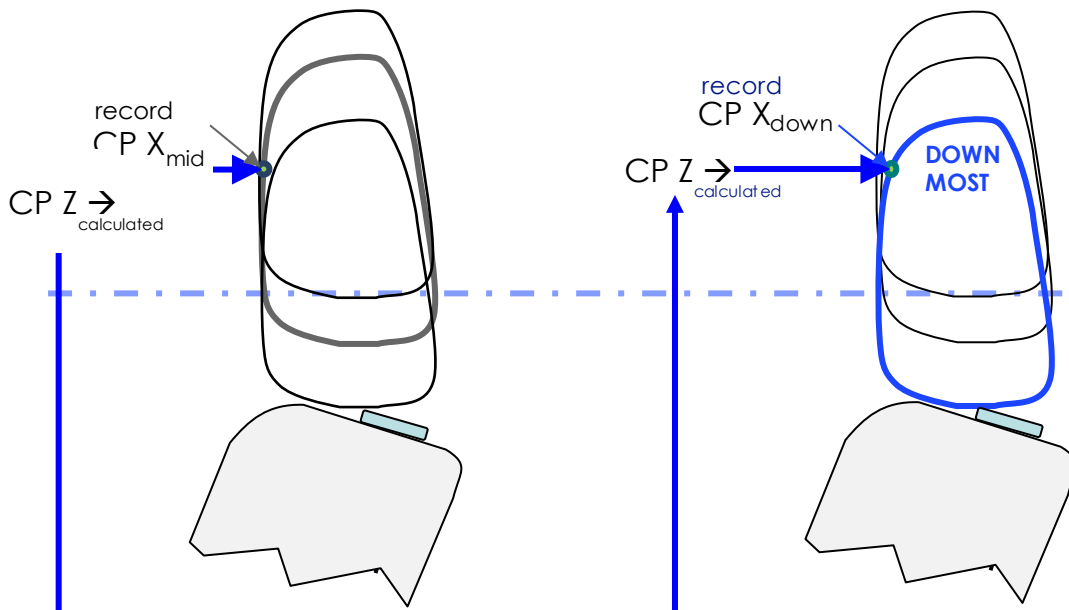

Figure 10: CP X and CP Z

6.2.4.4 Where CP cannot be determined because the horizontal line through the back-of-head of the mid-sized male is located above the head restraint, the head restraint must be raised to the next locking position to enable the determination of point CP.

6.2.4.5 In the instance where this will not produce a point of intersection, the CP will be designated at the horizontal top of the head restraint. The horizontal top of the head restraint being defined as the uppermost point on the head restraint, which is determined by lowering a horizontal line in the median longitudinal plane of the designated seating position until it touches the head restraint (see Figure 11). Where

more points are located at the same height, the longitudinally forward most point of the horizontal top of the head restraint is designated as CP.

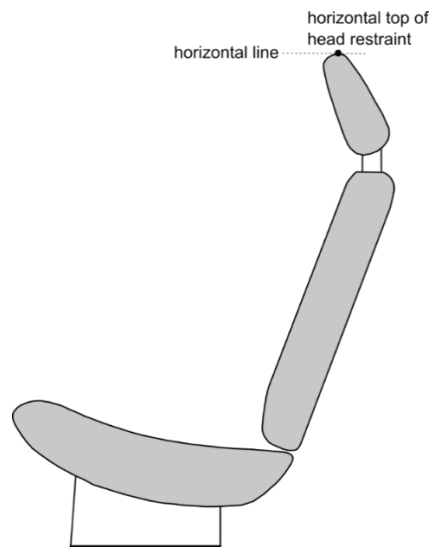

Figure 11: Determining CP

6.2.4.6 Where CP cannot be determined because the horizontal line through the back-of-head of the mid-sized male is on the level of a gap within the head restraint, CP will be determined using a 165 mm diameter sphere with its centre at the same height level as the horizontal line through the back-of-head of a mid-sized male.

6.2.4.7 When the sphere is making first contact with the head restraint, CP is designated as the rearmost point of the sphere in the gap area, see Figure 12.

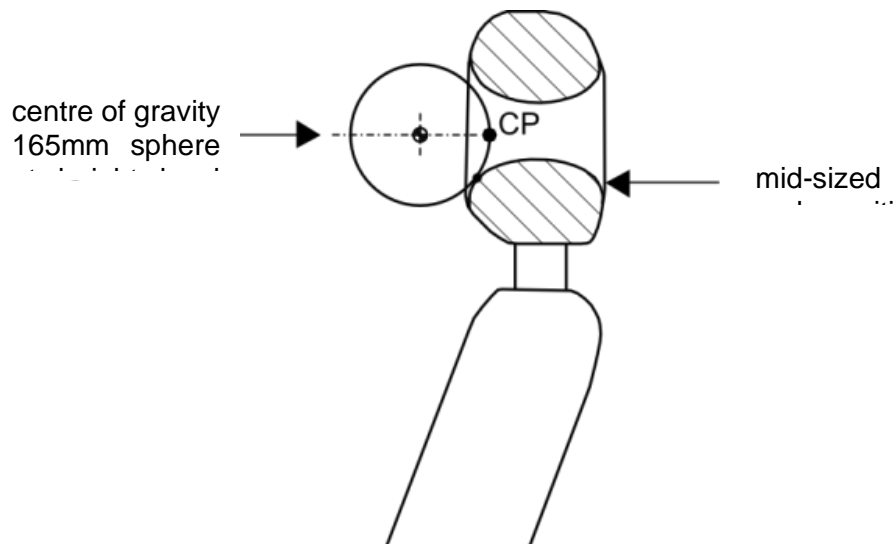

Figure 12: Determining CP

6.2.4.8 If the measured backset to point CP is negative and the head restraint has an adjustable backset, set the backset to the lowest positive backset value which can be obtained with a locking position of the head restraint. This new head restraint position will be the new test position and will be used for both dynamic tests with the BioRID.

6.2.4.9 CPx shall be measured in the head restraint test position and in the worst case position.

6.2.5 Determination of intersection point IP

6.2.5.1 Adjust the head restraint to the uppermost position. If the head restraint is adjustable for tilt or fore-and-aft, the tilt and fore-and-aft adjustment used for the determination of CP will be kept.

6.2.5.2 IP is determined on the front surface of the head restraint as the intersection with a vertical line rearwards of CP at the "distance x" (detailed in Appendix IV), see Figure 13.

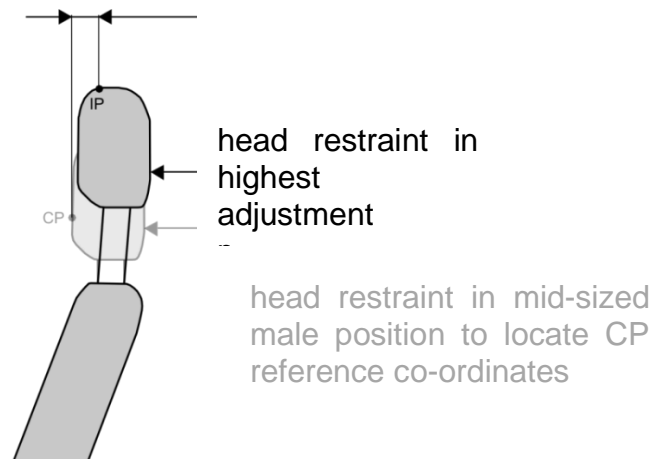

Figure 13: Determining IP

6.2.5.3 Where IP would be located rearwards of the horizontal top of the head restraint, IP will be designated at the horizontal top of the head restraint, see Figure 11.

6.2.5.4 Where the CP is designated at the horizontal top of the head restraint in Section 6.2.4.5, and there is no existing point of IP on the head restraint surface, IP is also designated on the horizontal top of the head restraint as determined in accordance with Section 6.2.4.5. See Figure 14.

6.2.5.5 The determined point "IP" will be kept in any adjustment position.

6.2.5.6 For head restraints not adjustable for height, IP is to be determined in the fixed position.

6.2.5.7 For two-way adjustable head restraints (e.g. up and down only) IP shall be measured in the test and lowest positions.

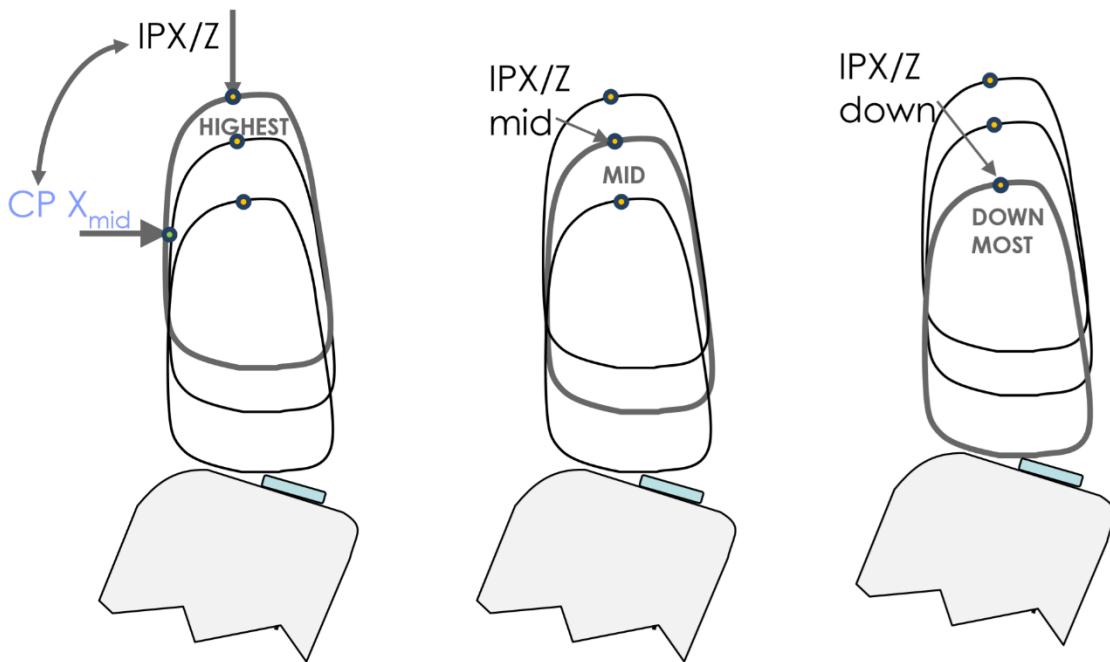

Figure 14: IP X and IP Z

6.2.5.8 For four-way adjustable head restraints (e.g. up and down plus fore and aft) IP shall be measured in the following positions:

Mid vertical position & mid fore/aft

Lowest vertical position (including where there is no lock) & fully rearward

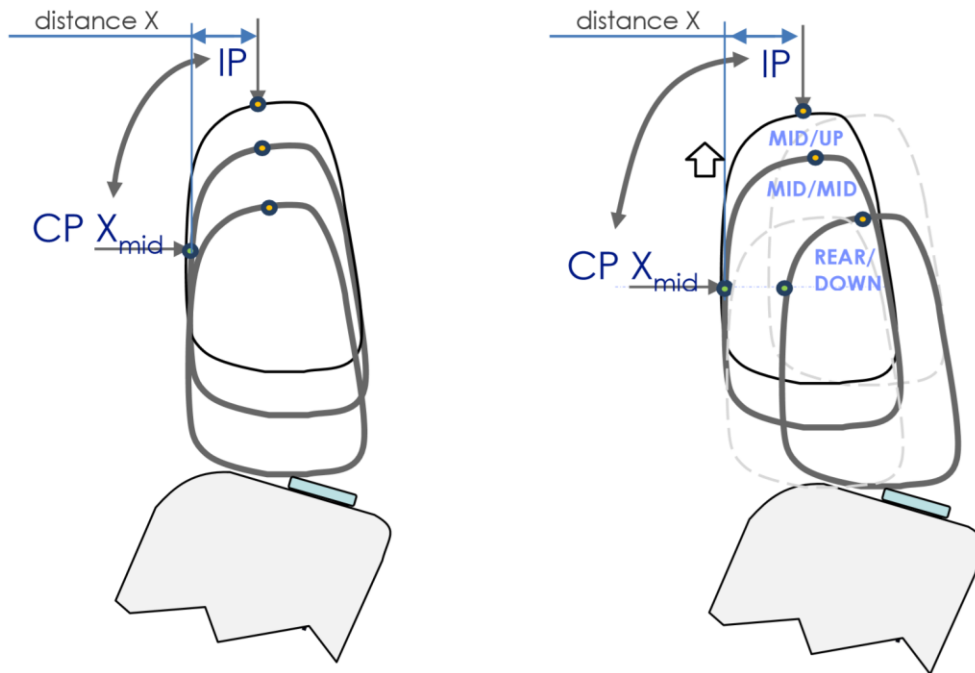

Figure 15: 2 way and 4 way head restraints

6.2.6 Determination of the highest head restraint height

6.2.6.1 The head restraint height is the distance from the R50-point, parallel to the torso reference line and limited by a line perpendicular to the torso reference line intersecting IP, see Figure 16.

6.2.6.2 After the coordinates of IP are determined, the head restraint height for each position to be assessed can be calculated by its longitudinal (ΔX) and vertical (ΔZ) distance from the R50-point (see Figure 16), as follows:

$$\text{Head restraint height} = \Delta X \cdot \text{SIN}(\text{design torso angle}) + \Delta Z \cdot \text{COS}(\text{design torso angle})$$

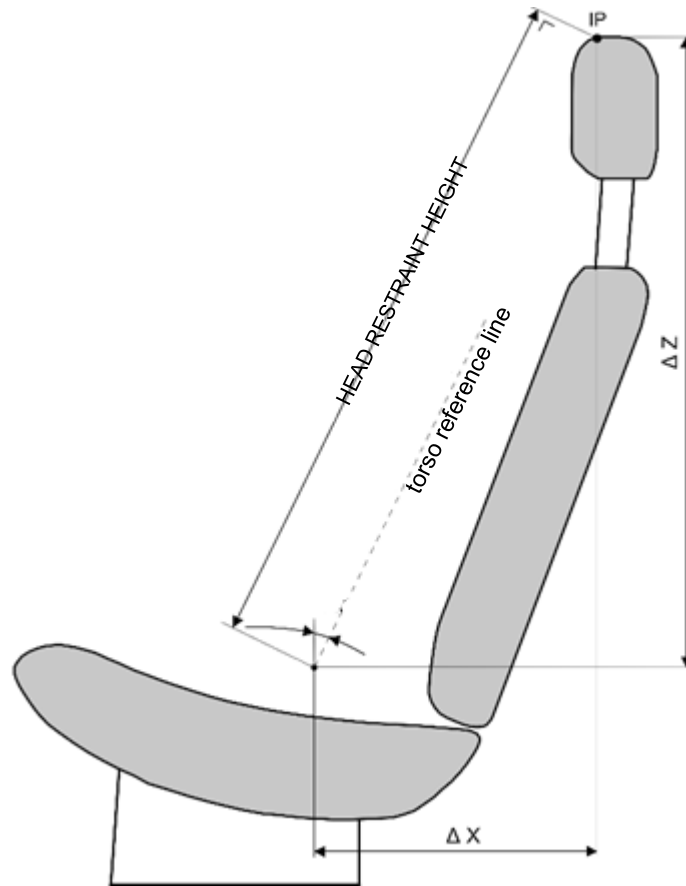

Figure 16: Head restraint height

6.2.7 Return the HR to the test position and measure IP X test position for effective height calculation and in the worst case position (lowest/most rearward).

6.3 Measure and Record Reference Geometry for BioRID Setup.

6.3.1 Back of the head reference position

6.3.1.1 The theoretical back of the head reference position for the BioRID UN, used to determine the reference backset, is the value determined for the 50th percentile in Appendix IV with reference to the specified torso angle minus 15 mm (increasing the backset as shown in Figure 17).

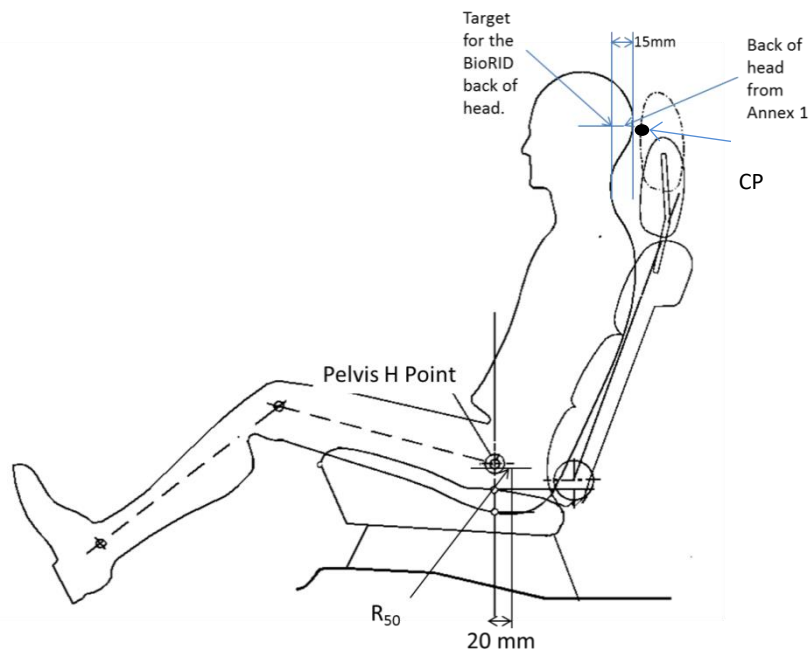

Figure 17: Measuring BioRID reference backset.

6.4 Install BioRID

- 6.4.1 The seat should have already been set to the required angle measured on the H-point machine as described in Section 5. Allow the seat to recover for 15 minutes with nothing in it before installing the BioRID. Note, BioRID handling should only be undertaken using dedicated lifting tools and associated locations on the dummy following the BioRID manufacturer recommendations. Typically, during the installation of BioRID the H-point will initially be installed further rearward in the seat than is required. Therefore, the pelvis should be moved forward to achieve the target set-up positioning.
- 6.4.2 Carefully place the seat belt across the dummy and lock as normal, ensure there is sufficient slack in the belt to allow positioning of BioRID.
- 6.4.3 Align BioRID's midsagittal plane with the centreline of the seat.
- 6.4.4 Adjust BioRID's midsagittal plane to be vertical; the instrumentation platform in the head should be laterally level.
- 6.4.5 Adjust the pelvis angle to the design torso angle plus $+1.5^\circ \pm 2.5^\circ$.
- 6.4.6 Position the H-Point 20mm forward ($\pm 10\text{mm}$) and at the same Z-height ($\pm 10\text{mm}$) as the location recorded in Section 5.2, while keeping the pelvis angle within the range specified in 6.4.5. It is recommended to aim to set the ATD as close as possible to the nominal target values, and that the tolerance window should only be used if there is an issue achieving the required H-Point target or backset value. The BioRID setup tolerances are summarised in Table 1.
- 6.4.7 Adjust the spacing of the legs so that the centreline of the knees and ankles is 200mm ($\pm 10\text{mm}$) apart and ensure that the knees are level using an inclinometer or bubble gauge.
- 6.4.8 Adjust the dummy's feet so that the heel of BioRID's shoe is resting on the heel surface. The tip of the shoe shall rest on the toe pan between 230mm and 270mm from the intersection of the heel surface and toe board, as measured along the surface of the toe board. Figure 2 shows proper positioning of the feet. Note, the heel

point from a vehicle is not replicated, only heel plane height is set according to vehicle geometry.

- 6.4.9 Position the BioRID's arms so that the upper arms are as close to the torso sides as possible. The rear of the upper arms should contact the seatback, and the elbows should be bent so that the small fingers of both hands are in contact with the top of the vehicle seat cushion with the palms facing the dummy's thighs. The arms may be used to stabilise the dummy posture if needed, for example with steep seat back angles, once the torso has been pushed rearwards to achieve the required backset.
- 6.4.10 Level the instrumentation plane of the head (front/rear and left/right directions) to within $\pm 1^\circ$. Electronic tilt sensors shall be used to perform this check.
- 6.4.11 If the BioRID measured backset is different from the BioRID reference backset obtained in Section 6.3.1 ($\pm 5\text{mm}$), then do the following:
 - 6.4.11.1 Tip the head for/aft no more than $+3.5^\circ / -0.5^\circ$ from level in order to meet the backset requirement.
 - 6.4.11.2 If the BioRID backset cannot be brought closer to the BioRID reference backset $\pm 5\text{mm}$ by step 6.4.11.1, adjust the pelvis angle and H-point position within their respective tolerance bands. In this case begin at Section 6.4.5 and adjust the BioRID position accordingly.
 - 6.4.11.3 If the BioRID backset cannot be brought closer to the BioRID reference position after adjustment of the head angle as specified above and if it is still not possible to set the test dummy backset measurement to within $15 \pm 5\text{mm}$ of the Back of the Head reference position specified in Section 6.3.1, then the dummy's pelvis angle and the H-point position shall be adjusted within their respective tolerance bands while prioritising the adjustment of the pelvis angle tolerance to achieve correct backset. It is not permitted to achieve the required position by pushing the dummy rearward, resulting in pre-loading of the BioRID, but the arms may be used to stabilise the torso.
- 6.4.12 Remove the slack from the lap section of the webbing until it is resting gently around the pelvis of the dummy. Only minimal force should be applied to the webbing when removing the slack. The route of the lap belt should be as natural as possible and must be above the pelvic angle gauge.
- 6.4.13 Place one finger behind the diagonal section of the webbing at the height of the dummy sternum. Pull the webbing away from the chest horizontally forward and allow it to retract in the direction of the D-loop using only the force provided by the retractor mechanism. Repeat this step three times, only.
- 6.4.14 Once the belt is positioned the location of the belt should be marked across the dummy chest to ensure that no further adjustments are made. Mark also the belt at the level of the D-loop to be sure that the initial tension is maintained during test preparation.

Table 1: BioRID setup summary.

Location	Target Measure	Tolerance
Backset	15mm forward*	± 5mm
H-point (X-axis)	+ 20mm forward**	± 10mm
H-point (Z-axis)	0mm**	± 10mm
Pelvis angle	Torso design angle +1.5°	± 2.5°
Head plane angle	0° (level)	± 1.0° (6.4.10) +3.5° / -0.5° (6.4.11.1)

* Reference measurements taken in accordance with Section 6.3.1.1

**Reference taken in accordance with Section 5.2

7 BIORID ATD REQUIREMENTS

7.1 BioRID Certification

7.1.1 The tests shall be conducted with a BioRID UN fitted with electronic tilt sensors capable of measuring X and Y tilt for head and pelvis. The instrumentation umbilical should exit at the front/side of the pelvis such that it is ensured there will be no seatbelt interaction. The dummy shall comply with both spine stature and all dynamic response specifications detailed in the BioRID UN user manual.

7.1.2 It is recommended that the BioRID be re-certified after every 15 tests.

7.1.3 All certification documents are to be provided in the laboratory test report.

7.2 Adjustment of Dummy Extremities

7.2.1 The stiffness of both arms and legs shall be checked and adjusted, where necessary, prior to every sled test. The adjustment procedure is as follows:

7.2.2 Arms

7.2.2.1 Extend the complete arm laterally outward to a horizontal position. Twist the arm so the elbow cannot rotate downward. Tighten the shoulder yoke clevis bolt so the arm is suspended at 1g, see Figure 18.

7.2.2.2 Rotate the complete arm assembly so it points forward and is horizontal. Twist the arm so the elbow cannot rotate downward. Adjust the shoulder yoke rotation hexagonal nut so the arm is suspended at 1g.

7.2.2.3 Bend the elbow by 90° so the hand moves toward the chest. Adjust the elbow rotation bolt through access in the upper arm to hold the lower arm horizontally suspended at 1g.

7.2.2.4 Reposition the arm so it points forward and is horizontal. Twist the lower arm at the elbow, so the lower arm can pivot downward to vertical. Adjust the elbow pivot bolt through access holes in the lower arm flesh at the elbow to hold the lower arm suspended at 1g, see Figure 18.

7.2.2.5 Extend the arm and twist the palm so it faces down. Adjust the wrist pivot bolt at the base of the hand so it is suspended at 1g.

7.2.2.6 Adjust the wrist rotation bolt through access in the wrist flesh to hold it suspended at 1g.

7.2.2.7 Repeat procedure for other hand and arm.

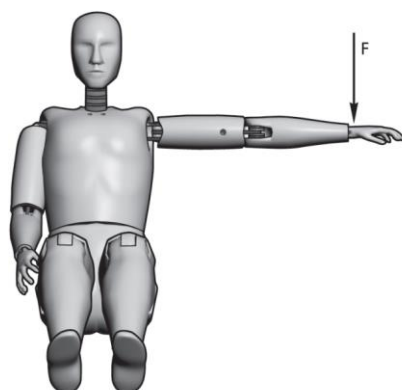

Rotation about the x-axis

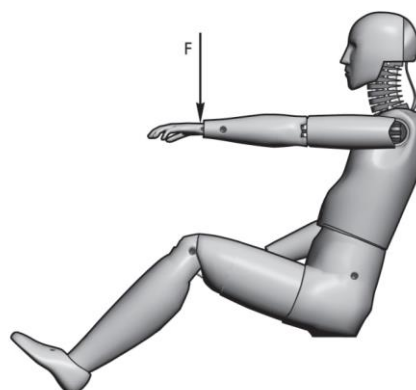

Rotation about the y-axis

Figure 18: Dummy extremity settings.

7.2.3 Legs

- 7.2.3.1 Remove the jacket from the dummy.
- 7.2.3.2 With the lower leg at 90° to the upper leg, and the dummy in seated position, lift the upper leg assembly above horizontal. Adjust the femur back set screw so the upper leg is held suspended at 1g.
- 7.2.3.3 Rotate the lower leg assembly so it is horizontal. Adjust the knee clevis bolt so the lower leg is held suspended at 1g.
- 7.2.3.4 Adjust the ankle ball joint screw so the foot is held suspended at 1g. The ankle adjustment is not critical and is determined by individual feet.
- 7.2.3.5 Repeat the procedure on the other leg and foot.

7.3 Clothing

- 7.3.1 The dummy should be dressed in two pairs of close-fitting, knee-length, spandex/lycra pants and two close-fitting, short-sleeved spandex shirts. The under layer of clothes should be worn with the shiny/smooth side of the fabric facing out and the over-clothes with the shiny/smooth side against the underclothes (i.e. dull side facing out). The dummies feet should be shod with size 11 (45 European) 320mm-325mm.

7.4 Instrumentation

- 7.4.1 The instrumentation required to perform the ANCAP evaluation is listed in Table 2. The T1 acceleration should be the average of right and left side accelerometer measurements. All instrumentation shall be calibrated before the test programme.
- 7.4.2 The channel amplitude class (CAC) for each transducer shall be chosen to according to Table 2. In order to retain sensitivity, CACs which are orders of magnitude greater than the minimum amplitude should not be used. A transducer shall be re-calibrated if it reaches its CAC during any test. All instrumentation shall be recalibrated after one year regardless of the number of tests for which it has been used. A list of instrumentation along with calibration dates shall be supplied as part of the test report.

Table 2: Required instrumentation (see also TB021 Data Format and Injury Criteria Calculation).

Position	Function	Measurement	CFC	CAC
Sled X	Pulse acceptance	Acceleration (g)	60	100
	Pulse acceptance	Velocity (m/s)	180	NA
	Rebound velocity	Displacement (m)	NA	NA
Head X	NIC	Acceleration (g)	60	100
		Acceleration (g)	1000	100
Head CoG X	Rebound velocity	Velocity (m/s)	30	NA
Neck T1 X (LH and RH)	NIC	Acceleration (g)	60	100

Position	Function	Measurement	CFC	CAC
Neck Force X Upper and lower		Force (N)	1000	1400
Neck Force X	My OC and Nkm	Force (N)	600	1400
Neck Force Z Upper		Force (N)	1000	4500
Neck Moment Y Upper and lower	My OC	Moment (Nm)	600	115
Head Restraint Contact Time (T- HRC)	T-HRC _{start} & T-HRC _{end}	Time (ms)	NA	NA
Neck T1 X		Force (N)	1000	5000
Neck T1 Z		Force (N)	1000	5000
Neck T1 Moment Y		Moment (Nm)	600	200
Neck T1 X		Acceleration (g)	60	200
Neck T1 X		Acceleration (g)	60	100
Neck T8 X		Acceleration (g)	60	200
Neck T8 X		Acceleration (g)	60	100
1 st Lumbar X		Acceleration (g)	60	200
1 st Lumbar Z		Acceleration (g)	60	100
Pelvis X		Acceleration (g)	60	200
Pelvis Z		Acceleration (g)	60	100

7.5 Data Acquisition and Processing

- 7.5.1 The measurement data shall be recorded according to ISO 6487 or SAE J211/1 at a minimum sample frequency of 10kHz Table 2 specifies the channel frequency classes for each necessary measurement.
- 7.5.2 Measurement data shall be considered for evaluation until the point in time at which the head rebounds from the head restraint or at 300ms after T-zero, whichever occurs first.
- 7.5.3 Prior to test all data channels shall be offset to zero, where zero (acceleration/force/moments) is defined by the average quiescent channel value over 100 samples at 10kHz (or equivalent) before time offset. This should be recorded a significant duration prior to T0 such that the sled acceleration/deceleration phase is avoided.

8 TEST SLED REQUIREMENTS

- 8.1 Acceleration Sled.** The dynamic test is intended to simulate a typical rear crash in which the rear-struck vehicle is initially stationary or moving forward very slowly. Consequently, an acceleration sled with the dummy seated facing the direction of motion is required for these tests. Some sled motion is allowed at the initiation of the test (T=0). To accommodate different sled types and different relationships between sled motion and the recording of test data, test time will be indexed as described in Appendix III. The sled should not brake before 300ms from T=0. A deceleration sled is no longer accepted for official ANCAP testing due to its inherently larger variability.
- 8.2 Test Time Indexing.** To normalise the time index among sled laboratory protocols with different T-zero trigger levels, the time indexing procedure described in Appendix III shall be used.
- 8.3 Laboratory Environment.** The temperature in the test laboratory should be $22.5^{\circ} \pm 3^{\circ}\text{C}$ and a relative humidity of between 10% and 70%. The BioRID test dummy and seat being tested shall be soaked at this temperature at least 3 hours prior to the test.
- 8.4 Acceleration Pulse.** The target sled accelerations and pulse specifications are given in Appendix III. Sled accelerations should be measured by an appropriate accelerometer attached to the sled platform, recorded according to SAE Recommended Practice J211 – *Instrumentation for Impact Testing – Part 1 – Electronic Instrumentation*. Prior to establishing conformance with the acceleration pulse specification, any quiescent signal bias should be removed from the acceleration measurement and the data should be filtered in accordance with Table 2.

9 TEST SLED INSTRUMENTATION

- 9.1** Record the X-acceleration of the sled in accordance with SAE recommended practice J211. The instrumentation should be directly attached to the sled platform and not to any other part of the test device.
 - 9.1.1 If necessary, remove any data channel DC bias. Typically, the value of the average measurement over 100 samples of the quiescent data channel signal is subtracted from every test measurement.
 - 9.1.2 Filter the sled acceleration to channel frequency class in accordance with Table 2.
- 9.2** The time of dummy head to head restraint first contact shall be recorded with a foil contact switch.

10 WHIPLASH ASSESSMENT CRITERIA

10.1 Criteria

The purpose of the whiplash test is to test the seat and head restraint assembly in order to assess the extent to which they reflect best practice in preventing soft tissue neck injuries. This is based on the following performance criteria:

- Head Restraint Contact Time (T- HRC_(Start) T- HRC_(End))
- T1 x-acceleration, T1
- Upper and Lower Neck Shear Force, Fx
- Upper Neck Tension, Fz
- Upper and Lower Neck Moment, My
- Head Rebound Velocity
- NIC
- Nkm
- Seatback Dynamic Opening.

Details of how the criteria are provided in Euro NCAP TB021 “Data Format and Injury Criteria Calculation”. Further details on the calculation of certain criteria are given below.

10.2 Head Restraint Contact Time T-HRC_(Start) T-HRC_(End)

Head restraint contact time should be ascertained using a contact switch method, comprised of a proprietary lightweight, self adhesive conductive foil placed over the surface of the head restraint, and the rear of the ATD skull cap.

Minor breaks in the contact time (up to 1ms) are permissible if it can be proven that these are due to poor electrical contacts, however these must be investigated with reference to the film to ascertain whether the breaks in contact are not due to biomechanical phenomena such as ATD ramping, head restraint or seatback collapse, or ‘bounce’ of the head during non-structural contact with the head restraint.

10.3 T1 X-Acceleration

BioRID is fitted with twin accelerometers on the first thoracic vertebra (T1), one on either side of the lower neck loadcell assembly. The data channels acquired from these accelerometers should both be filtered to channel frequency class detailed in TB021.

10.4 Head Rebound Velocity – Acceleration Sled Technique

The head rebound velocity (in the horizontal/X direction) should be determined using target tracking. Refer to the Euro NCAP Film and Photo protocol for additional considerations regarding the use of high speed cameras.

10.4.1 Time for Occurrence of Peak Rebound Velocity. Theoretically, the peak rebound velocity should occur due to the elastic energy release from the seat assembly, after the peak sled acceleration has occurred. In the case of an acceleration sled this should also be prior to the sled braking, which at the earliest should occur from 300ms. It should be verified that there is sufficient time before the onset of sled braking for the particular sled being used, and that any peak rebound velocity

analysis is not undertaken during the sled braking phase. The rebound velocity of the ATD is usually generated due to the release of stored elastic energy within the seat structure, suspension and foam. The time of occurrence of peak rebound velocity should be the maximum horizontal component of head rebound velocity calculated between T=0 and 300ms.

10.4.2 The ATD shall be equipped with a suitable target placed on the side of the head flesh, coincident with the head centre of gravity. Additionally, three sled targets will be required. Two fixed targets of known separation should be placed on the sled in the same XZ plane, such that a fixed reference can be obtained that will not be obscured during the test (B1 and B2 targets). In the case of an onboard view, a small compensation may be required for camera movement or shake. This can be made using the two fixed targets of known spacing on the sled, and a third target from which a sled coordinate system may be created. All target points used for analysis should be depth scaled to compensate for any differences in the Y-coordinates.

10.4.3 Determination of Rebound Velocity

The peak rebound velocity should be verified using the end of head restraint contact time, T-HRC_(end), that this maximum is during the rebound from the head restraint and is not generated within the sled braking phase. Should higher peaks be generated in the sled braking phase, these should be disregarded and the initial peak of rebound velocity which occurs at or very near to initial rebound from the head restraint should be taken as the peak value.

10.5 NIC Calculation

The NIC is based on the relative horizontal acceleration and velocity of the occipital joint relative to T1. To calculate NIC, two data channels are needed, which are the head x-acceleration and average T1 x-acceleration.

Each channel should first be converted from 'g' to metres per second squared (m/s²), and the head x-acceleration should be filtered as defined in TB021. The average T1 channel (previously calculated) is the result of combining two channels, both of which were filtered as defined in TB021.

10.6 Nkm Calculation

The following definition is provided following the commonly accepted convention that derives the "Anterior/ Posterior" directions from the torso motion relative to the head. Consequently, torso forward motion relative to the head would be referred to as 'anterior', and providing SAE J211 compliant instrumentation is used, would produce an associated positive upper neck shear force, F_x^{upper} . ("Head rearward relative to the torso")

Conversely, the movement of the torso rearward relative to the head is referred to as 'posterior' and produces the opposite sign of shear force.

The Nkm criterion is based on a combination of moment and shear forces, using critical intercept values for the load and moment. The shear force intercept value is identical for anterior or posterior values, being 845N in both directions of loading. However, the critical intercept value for the bending moment depends on the direction of loading, having a value of 47.5Nm in extension (head rotation rearwards), but a value of 88.1Nm in flexion (head rotation forwards).

Two channels will be required to perform the Nkm calculation, upper neck shear force F_x^{upper} , in Newtons (N) and moment, M_y^{upper} in Newton-metres (Nm).

Typically the shear force will be acquired in kilo-Newtons (kN), and so in those cases, a conversion from kilo-Newtons (kN) to Newtons (N) will be required.

Once it has been confirmed that both shear force and moment are in the correct units, filter M_y^{upper} as defined in TB021. To allow combination of the M_y^{upper} and F_x^{upper} channels, another F_x^{upper} channel should be produced, filtered as defined in TB021. Due to the construction of the BioRID, a correction must then be made to convert the actual moment measured by the upper neck loadcell into the moment about the Occipital Condyle (OC).

The corrected moment, M_y^{OC} is equal to the upper neck shear force F_x^{upper} multiplied by a constant, D, then subtracted from the measured moment, M_y^{upper} . Calculate the Moment about the OC according to TB021.

The four components of Nkm are then calculated using the upper neck shear force F_x^{upper} and the corrected moment about the OC, M_y^{OC} .

Each channel first needs to be separated into its positive- or negative-going components by generating four new channels as follows:

Generate two new channels, F_{xa} and F_{xp} , based on F_x^{upper} force channel.

Generate two new channels, M_{yf} and M_{ye} based on the M_y^{OC} moment channel.

Each of the new channels should contain only selected positive or negative-going portions of the respective F_x or M_y channels, with all unwanted data points being replaced by null or zero value, as defined by:

F_{xa} channel contains only the positive portion of the F_x^{upper} force channel as follows:

$$\text{If } F_x^{upper}(t) > 0, \text{ then } F_{xa}(t) = F_x^{upper}(t), \text{ else } F_{xa}(t) = 0$$

F_{xp} channel contains only the negative portion of the F_x^{upper} force channel as follows:

$$\text{If } F_x^{upper}(t) < 0, \text{ then } F_{xp}(t) = F_x^{upper}(t), \text{ else } F_{xp}(t) = 0$$

M_{yf} channel contains only the positive portion of the M_y^{OC} moment channel as follows:

$$\text{If } M_y^{OC}(t) > 0, \text{ then } M_{yf}(t) = M_y^{OC}(t), \text{ else } M_{yf}(t) = 0$$

M_{ye} channel contains only the negative portion of the M_y^{OC} moment channel as follows:

If $M_y^{OC}(t) < 0$, then $M_{ye}(t) = M_y^{OC}(t)$, else $M_{ye}(t) = 0$

The four components of Nkm are then defined as:

1) “Neck Extension Posterior” (N_{ep}) or the combined negative-going portion of the shear force channel (F_{xp}) and negative-going portions of the moment channel (M_{ye}), as defined by TB021.

2) “Neck Extension Anterior” (N_{ea}) or the combined positive-going portion of the shear force channel (F_{xa}) and negative-going portions of the moment channel (M_{ye}), as defined by TB021.

3) “Neck Flexion Posterior” (N_{fp}) or the combined negative-going portions of the shear force channel (F_{xp}) and positive-going portions of the moment channel (M_{yf}), as defined by TB021.

4) “Neck Flexion Anterior” (N_{fa}) or the combined positive-going portions of the shear force channel (F_{xa}) and positive-going portions of the moment channel (M_{yf}), as defined by TB021.

Each of the four components should be calculated as a new data channel, using only the positive- or negative-going portions of the Fx and My channels as appropriate, and the relevant critical intercept values. Maxima for each of the four components should be calculated.

10.7

Seatback Dynamic Deflection

The Seatback Dynamic Opening is defined as the maximum change in angle achieved at any time during the test between the T zero position and T-HRC_(end). Note this maximum angle, and the time at which it occurred.

For seats with two-point adjusting back, the same seatback deflection criterion will apply using targets ST2 and ST3, however it is recommended to use the two optional targets ST2' and ST3' (defined in the Euro NCAP Film and Photo protocol) such that any contribution from deflection in the two point mechanism can be understood.

Appendix I

MANUFACTURERS SPECIFIED SETTINGS

Prior to preparation of the sled and seats, the following information should be provided by the manufacturer to allow for the test preparation.

Adjustment	
Whiplash preparation	
Seat mounting information, drawings etc.	Required information: <ul style="list-style-type: none"> • Floor mounting pattern • Seat rail angles • Seat rail travel (especially if different on both sides) • Fixation/support information Alternatively, the manufacturer may supply suitable seat mountings to the laboratory.
Heel plane height	
Seat belt anchorage positions	Where required.
Anticipated seat settings Seat back angle (e.g. 3 notches from forward)	<ul style="list-style-type: none"> • Seat back angle reference point wrt. seat reference point or HR tube angle.
Triggering information for active systems (pre-tensioners, active HR, etc.)	<ul style="list-style-type: none"> • Triggering system details, ALL relevant information (magnetic, electronic, required current/voltage, pulse duration etc.)
R50-point location	<ul style="list-style-type: none"> • Relative to an identifiable location on the seat.
Seat back design angle (torso angle must be the same as used in the full scale impact tests)	Required information: <ul style="list-style-type: none"> • Fixed origin on seat runners • Identifiable points on the seat frame relative to origin • Identifiable points on HR relative to origin. • Other identifiable locations where necessary. •

Appendix II

RCAR GLORIA JIG & CALIBRATION PROCEDURE*

1 Introduction

For the purposes of standardised seating positions for anthropomorphic test devices the SAE (Society of Automotive Engineers) designed the H-Point Machine (H-PM) that allowed a uniform definition of the human H-Point. Much of this work was completed in the late 1950's with the machine still in constant use today. The SAE J826 procedure [1] was also defined to allow consistent and authoritative H-points and seating reference points to be defined.

Research studies from Thatcham [4] and Partnership for Dummy Technology and Biomechanics (PDB) [5] have both shown the location of the H-point on different H-PMs shows little variability. However the location of the weight hangers shows some variability, and this location is not controlled by any calibration procedure.

2 Scope

This procedure is designed to allow the calibration of H-PM to restrict build tolerance variations of items currently poorly controlled and allow more repeatable and reproducible results.

3 Definitions

3.1 H-Point Machine (H-PM/OSCAR)

Machine defined to locate the H-point. H-PMs can be either the SAE J826 or 3D-H type of manikin, from the US or Europe respectively. It represents a 50th percentile adult male mass and basic morphology. It consists of a moulded GRP seat/ buttock pan with a metal spine to which are attached weights to represent the average human male. The unit has one central pivot around the pelvis a point which corresponds with that of the H-point. The unit has legs and articulated feet which are all adjustable to represent different percentiles. The unit has attached to the main pivot a height probe and inclinometer not used in the head restraint measurement process. Also known as OSCAR.

3.1.1 SAE J826 Seating Manikin

The US version of the H-PM.

3.1.2 3D-H Seating Manikin

The European version of the H-PM without the force plunger or thigh bar and with an additional 1 kg mass.

4 Equipment Requirements

4.1 H-PM Calibration Jig

The H-PM unit is held in a jig, known as GLORIA, which will facilitate calibration. The jig is

* Source: RCAR Procedure, Version 1.3 Version: July 2007

equipped with feet at each corner to facilitate levelling. The jig holds the seat pan by three horizontal bars of 20mm thickness that support the seat pan allowing the thigh bar to be horizontal. The back pan is supported by 900mm vertical bar with its origin at the base of the seat pan in the area of the buttock. This vertical support has a horizontal bar at the level of the weight hanger bar and is level. A cord is attached to the back pan to prevent the H-PM falling forward.



Figure 19: H-PM Calibration Jig (GLORIA)

5 Set Up and Assembly of GLORIA Jig

- 5.1** The calibration should be carried out in a room with temperature at $20^{\circ}(\pm 5^{\circ})$, H-PM and GLORIA jig should have been soaked in that same environments for 6 hours prior to commencing with step 3.2.
- 5.2** The GLORIA jig should be set on a nominally level surface and levelled by adjustment of the threaded feet. The base plate should be levelled using an inclinometer. Surfaces to be used as reference are the lower horizontal section of the side rails and the seat pan support rods. Then the front and side surfaces of the vertical support should be checked to ensure the column is still vertical. All four measurements should be undertaken to ensure the unit is level. Tolerance for this levelling operation is $\pm 0.1^{\circ}$.
- 5.3** Remove the H-Point locator rods from the jig left and right.
- 5.4** Remove the Vertical H-Point to weight hanger bar supports along with the weight hanger guide assembly by extracting the removable rods.
- 5.5** Loosen the 4 bushes on the seat pan front and rear horizontal support bars and slide them outboard.

6 Preparation of H-PM prior to Calibration

- 6.1** Remove the H-Point locator plugs from the seat pan left and right.
- 6.2** When re-assembling the H-PM manikin without the Head Room Probe care should be taken to ensure that the H-Point pivot nuts are tightened to a torque of X-Y Nm. When set at this torque the manikin back pan can fall forward hence the use of the support strap.

7 Installation and Calibration of H-PM

- 7.1** Fold the H-PM forward to allow easier installation into the jig.
- 7.2** Install the H-PM into the jig ensuring that the rear of the seat pan is in contact and square to the rear upper horizontal bar.
- 7.3** Centre the seat pan on the horizontal support bars and slide the bushes inboard allowing them to contact the seat pan. Tighten the bushes' set screws.
- 7.4** Adjust the rear Concentric Adjustment Bar from both sides to visually align the H-point holes forward and aft on the H-PM seat pan with the corresponding holes on the side plates of the jig.
- 7.5** Adjust the lower Concentric Adjustment Bar from both sides to visually align the H-point holes up and down on the H-PM seat pan with the corresponding holes on the side plates of the jig.
- 7.6** Install the H-Point locator rods through the vertical support guides and then into the H-point guides of the jig base and then through to the H-point holes on the H-PM (Figure 20).



Figure 20: H-Point locator bars installed through vertical support rods, jig side and H-PM H-Point location.

- 7.7** Adjust the front Concentric Adjustment Bar from both sides to level the T-bar ($\pm 0.5^\circ$).
- 7.8** Check for horizontal play in the H-PM at the H-Point / torso pivot to check for excessive wear. Tighten or replace as necessary.
- 7.9** Raise the back pan until it rests upon the jig's vertical support bar and secure with the elastic strap to prevent the back from tipping forward (Figure 21).



Figure 21: H-PM back pan held by retaining strap.

- 7.10** Install the weight hanger alignment fixture over the weight hangers to check for alignment. The fixture should be allowed to settle under its own weight, no force should be applied to fit. If this fixture will not locate then it indicates that the weight hanger bars are out of alignment and will require modification and the procedure should be terminated.
- 7.11** Remove the weight hanger alignment fixture and support strap. Tip the back pan forward and install the black cylindrical weight hanger bar guides at each out board end of the H-PM weight hanger bars between the bars and the jig arms. Replace the back pan and support strap.
- 7.12** Visually check alignment of the weight hanger bar guides with the holes in the jig arms.
- 7.13** If alignment is correct then proceed. If it is not possible due to interference between the H-PM back pan and vertical support then adjustment of the back pan to seat pan offset will be necessary which is outside the scope of this document. This procedure should therefore be terminated here.
- 7.14** If the alignment is not possible due to the misalignment of the H-PM's weight hanger support rods then these should be adjusted to achieve alignment.
- 7.15** Raise the weight hanger guide bars either side of the jig and insert the weight hanger locator pins through the guide bars, arms and into the black cylindrical weight hanger bar guides (Figure 22).



Figure 22: Weight hanger support pins inserted through weight hanger guide bars.

8 Calibration of the H-PM Unit

- 8.1** Once installed in the jig check to ensure that the flat portion of the H-PM back pan is parallel to the vertical jig support and that the gap is no more than 4mm. It is allowed to touch (Figure 23).



Zero to 4mm gap
between H-PM back
pan and jig support

Figure 23: H-PM installed into the jig. A check should be made to ensure that the gap between the H-PM back pan and jig vertical support is no more than 4mm.

9 Attachment of Torso Angle Measuring Surface

- 9.1 Measure the trunk of the left hand weight hanger with a digital inclinometer (Figure 24).



Figure 24: Measurement being taken of the torso angle at the weight hanger trunk by a digital inclinometer.

- 9.2 A calibrated Angle Measuring surface block should then be attached to ensure the left hand weight hanger trunk to ensure that an angle of $90^\circ (\pm 0.3^\circ)$ is indicated), Figure 25.
- 9.3 If the angle of the left hand weight hanger is not at $90^\circ (\pm 0.3)$ then a calibrated and adjusted surface block should be installed in place of the standard item.
- 9.4 Check the angle of the installed calibrated surface block with a digital inclinometer to ensure that it shows a reading of $90^\circ (\pm 0.3^\circ)$.



Figure 25: Calibrated Torso angle measurement surface block attached to trunk of weight hanger arm.

Appendix III

SLED PULSE SPECIFICATIONS

1 Definitions

1.1 Offset Adjust the Accelerometer

In order to make sure that there is no initial acceleration, which result in a non-zero velocity profile, it is required to offset adjust the acceleration signal. It is assumed that this step is a standard procedure for the participating laboratories and shall therefore not be discussed into further detail.

1.2 Filter with CFC60

To ensure that low level noise does not influence the results the acceleration signal is filtered with a CFC 60 filter ('endpoints'-method in Diadem). The CFC 60 filter is used according to SAE J211, for sled acceleration signals.

1.3 Definition of T0

T0 is defined as the time before the CFC60 filtered sled acceleration reaches 1.0g. The times for the medium and high pulses are 5.8ms and 3.7ms respectively.

1.4 Definition of T1

T1 is defined as the time when the sled acceleration for the first time is > 1g. Both the initial onset of the pulse and specific low acceleration disturbances (< 0.5g) heavily influence the behaviour at the start of the pulse. For that reason, it is in practice not possible to identify the actual start of the pulse. Acceleration levels higher than 1g however are unmistakably a direct result of the pulse on the sled. As such, the moment in time when the sled acceleration crosses 1g can be uniquely and easily be found.

1.5 Definition of TEND

TEND is defined as the time when the sled acceleration for the first time is < 0g.

1.6 Definition of dT

dT is defined as the time span between TEND and T0,

$$dT = TEND - T0$$

1.7 Definition of dV

dV is defined as the difference between the maximum and minimum sled velocity between T0 and TEND, filtered at CFC180.

2 [NOT USED THIS VERSION]

3 Medium Severity Sled Pulse Requirements

The sled acceleration must be within the corridors for the complete time interval from 0ms to 150ms as illustrated in Figure 26. The corridor data points are detailed in Table 3. The data points for the rise corridor, C, D E & F, are described in Table 4.

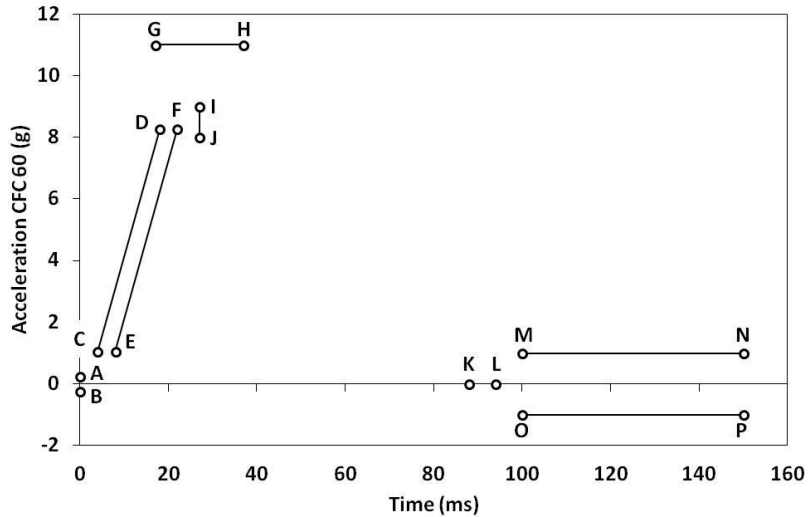

Figure 26: Medium severity pulse corridors

Table 3: Medium pulse requirements

Parameter		Requirement	Limits +/-	Unit	
Velocity change	dV	15.65	0.80	km/h	
Mean acceleration	Amean	47.85	4.00	m/s ²	
	Time (ms)	Acceleration (g)		Time (ms)	Acceleration (g)
A	0	0.25	I	27	8.00
B	0	-0.25	J	27	9.00
C	4	1.0531	K	88	0.00
D	18	8.2705	L	94	0.00
E	8	1.0531	M	100	1.00
F	22	8.2705	N	150	1.00
G	17	11.00	O	100	-1.00
H	37	11.00	P	150	-1.00

Table 4: Medium pulse rise corridor

Time (ms)	Acceleration (g)	Time (ms)	Acceleration (g)
(C) 4	1.0531	(E) 8	1.0531
5	1.3751	9	1.3751
6	1.7443	10	1.7443
7	2.1608	11	2.1608
8	2.6230	12	2.6230
9	3.1276	13	3.1276
10	3.6691	14	3.6691
11	4.2406	15	4.2406
12	4.8336	16	4.8336
13	5.4384	17	5.4384
14	6.0446	18	6.0446
15	6.6414	19	6.6414
16	7.2181	20	7.2181
17	7.7645	21	7.7645
(D) 18	8.2705	(F) 22	8.2705

4 High Severity Sled Pulse Requirements

The sled acceleration must be within the corridors for the complete time interval from 0ms to 150ms as illustrated in Figure 27. The corridor data points are detailed in Table 5 along with additional requirements for the high severity sled pulse.

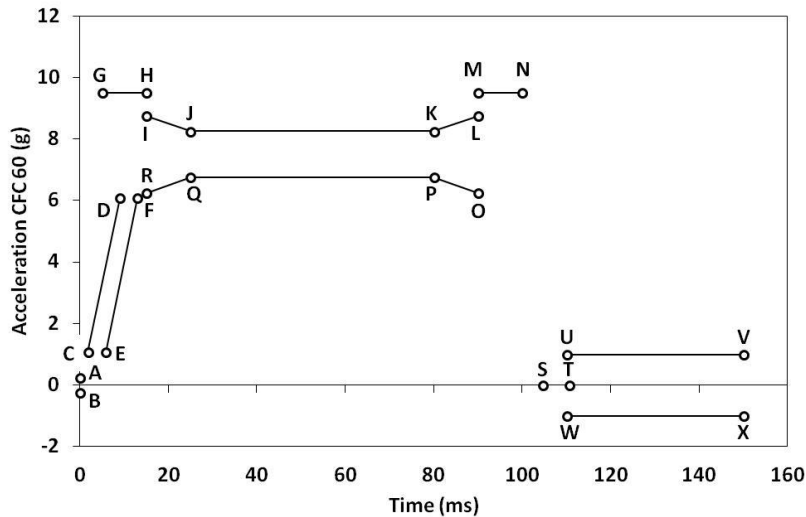

Figure 27: High severity pulse corridors.

Table 5: High pulse requirements

Parameter		Requirement	Limits +/-	Unit	
Velocity change	dV	24.45	1.2	km/h	
Mean acceleration	A _{mean}	63.15	4.85	m/s ²	
Maximum acceleration	A _{max}	7.50	0.75	g	
	Time (ms)	Acceleration (g)		Time (ms)	Acceleration (g)
A	0	0.25	M	90	9.50
B	0	-0.25	N	100	9.50
C	1.8	1.0714	O	90	6.25
D	9	6.0880	P	80	6.75
E	5.8	1.0714	Q	25	6.75
F	13	6.0880	R	15	6.25
G	5	9.50	S	104.7	0.00
H	15	9.50	T	110.7	0.00
I	15	8.75	U	110	1.00
J	25	8.25	V	150	1.00
K	80	8.25	W	110	-1.00
L	90	8.75	X	150	-1.00

The target rise of the low severity pulse has been calculated using the following formula:

$$\frac{A_{\max}}{2} \left\{ 1 - \cos \left(\frac{(t)\pi}{15.4} \right) \right\}$$

To establish the rise corridor C, D E & F, the portion of the target pulse from 3.8ms to 11.0ms is time shifted by -2.0ms for points C & D and +2.0ms for points E & F. This corridor should be calculated between time (t) = 3.7ms to 11.0ms.

Appendix IV

Head position table

Location of the back-of-head of two designated males in automotive posture with respect to the R50-point at several design torso angles, and their in-between "distance x"

Design torso angle	X-coordinate of back-of-head calculated for the mid-sized male	Z-coordinate of back-of-head calculated for the mid-sized male	X-coordinate of back-of-head calculated for large male ²	"Distance x": distance between X-coordinates of back-of-head of both males
	$504.5 \cdot \sin(\text{design torso angle} - 2.6) + 71$	$504.5 \cdot \cos(\text{design torso angle} - 2.6) + 203$	$593 \cdot \sin(\text{design torso angle} - 2.6) + 76$	$88.5 \cdot \sin(\text{design torso angle} - 2.6) + 5$
5	92	707	101	9
6	101	707	111	10
7	110	706	121	12
8	118	705	132	13
9	127	704	142	15
10	136	703	152	16
11	145	702	163	18
12	153	701	173	19
13	162	699	183	21
14	171	698	193	22
15	179	696	203	24
16	188	694	213	26
17	196	692	223	27
18	205	689	233	29
19	213	687	243	30
20	222	684	253	31
21	230	682	263	33
22	239	679	273	34
23	247	676	283	36
24	255	673	292	37
25	263	669	302	39
26	271	666	312	40
27	279	662	321	42
28	287	659	330	43
29	295	655	340	44
30	303	651	349	46

The large male is represented by a virtually up-scaled Torso and Neck Link; where the mid-sized male version of the Torso and Neck Link measures 504.5 mm and 203 mm with the head room probe 71 mm rearwards, the up-scaled version for the large male measures respectively 593 mm and 219 mm with the head room probe 76 mm rearwards